



2024
CATALOG



**INTERNATIONAL
STAIR PRODUCTS INC**



1628 W. Crosby Road, Suite 109
Carrollton, TX 75006
469-453-6744
www.intlstairproducts.com



Our Story



**INTERNATIONAL
STAIR PRODUCTS INC**

Your complete stair parts and floorings supplier.

Established in Dallas, Texas in 2016, we partner with the world's largest stair parts manufacturer who servicing over 50 countries Worldwide. We offer stair parts including handrails, newels, balusters, wood steps, cove moldings, S4S materials, floorings and more.

The wood species we specialize include North American Red Oak, White Oak, Maple, Poplar, Hickory, and so on. We carry stair parts with a large selection of colors, designs, and finishes to

complete the look of your new home or your remodeling project.

In ISP, we believe satisfied customers are our best ads, and we are thrived to provide with the best value for your purchases. The quality of our products and services is always our first priority; and seeing your smile is our ultimate pursuit.

International Stair Products, Inc. - the optimum source and an one-stop solution for all your staircase, trim, and flooring needs.

Valuable Services



Place your order today! Pick up your material the same day or have us delivered to you the next business day.

469.453.6744

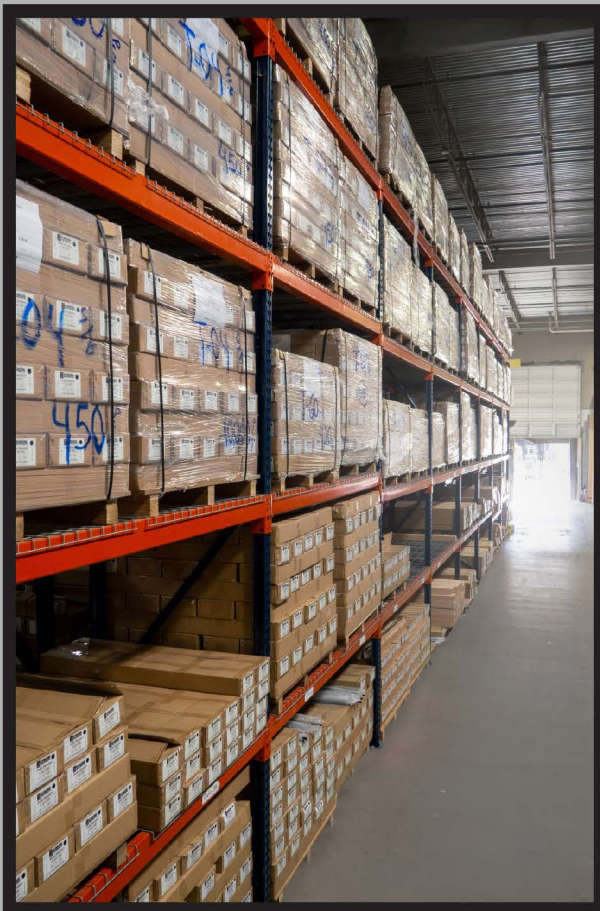



www.intlstairproducts.com



**INTERNATIONAL
STAIR PRODUCTS INC**

Stair Anatomy

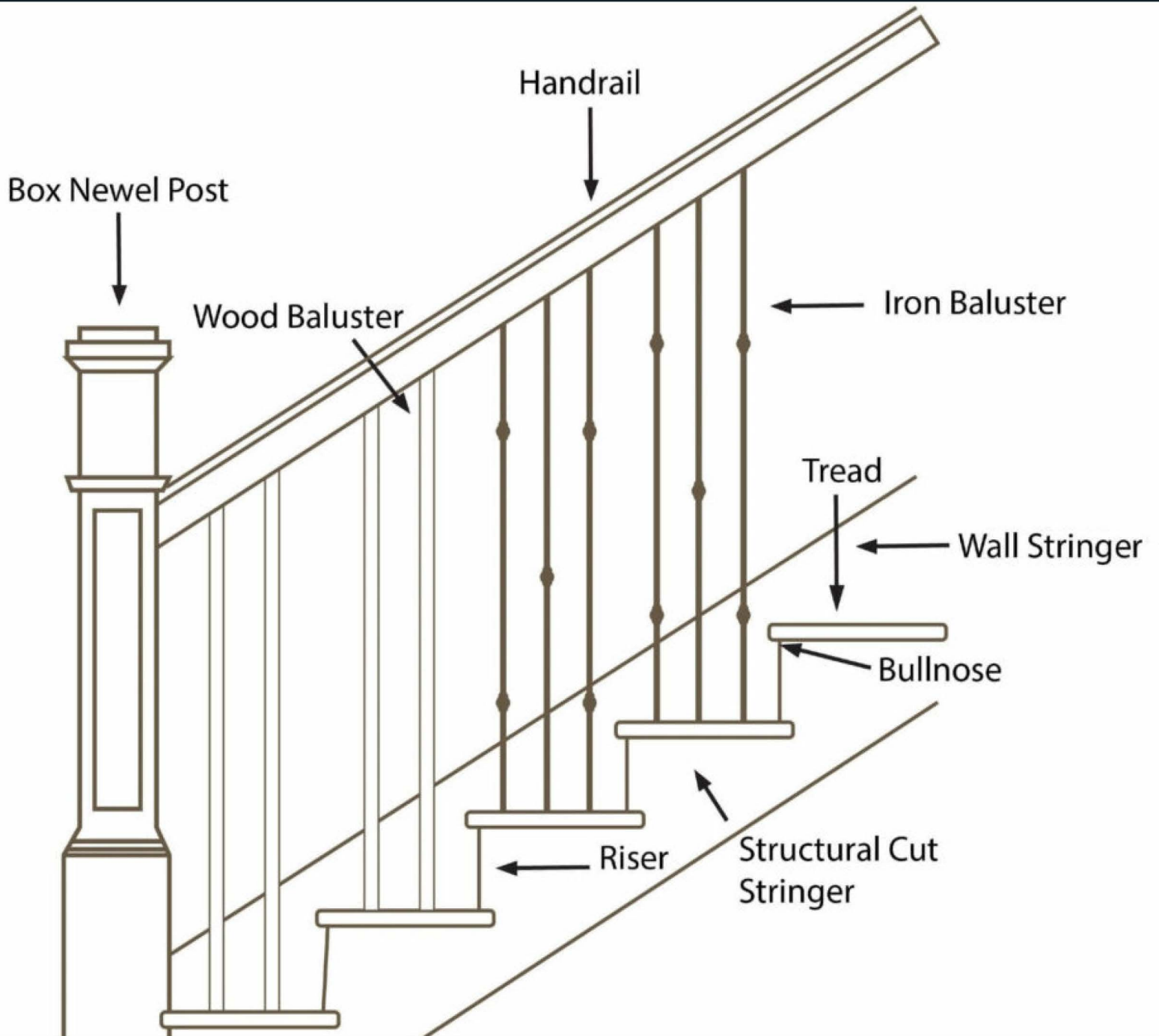

Table of Contents

Wood Collection	6
Wood Balusters	8
Wood Newels	10
Box Newels	17
Wood Fittings	21
Wood Handrails - Straight	30
Wood Handrails - Bending	31
Wood Starter Steps	33
Wood Treads	37
Riser & S4S	39
Cove & Trim	41
Iron Collection	43
Hollow Metal Balusters	45
Solid Metal Balusters	61
Mega Balusters	62
Horizontal Balusters	64
Iron Newels	66
Metal Shoes	69
Accessories	73
Flooring	77

Wood Collection

Wood Species Guide



Red Oak



White Oak

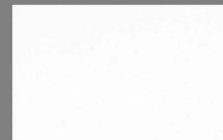

Prime



Maple

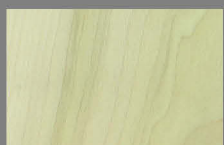

Poplar





Wood Balusters





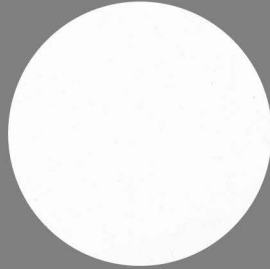





Red Oak



Prime

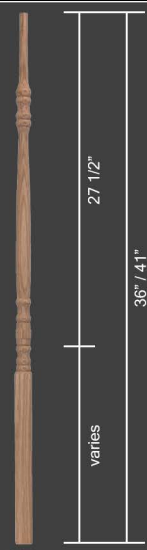
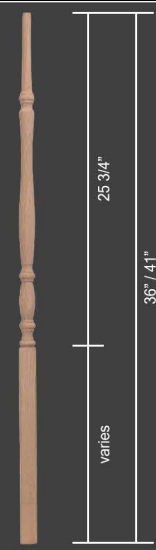

		
4120	4611	5005
		
5015	5060	5141
		
5200	5241	5360



Wood
Newels

Acorn Top



4005AT
3 1/2" x 56"



4442TW
3 1/2" x 54"



5160 3 1/4
3 1/4" x 54"



5160 4 1/2
4 1/2" x 54"



5160 6
6" x 54"



5165
3 1/4" x 54"



5170
3 1/4" x 54"



5175
3 1/4" x 54"



Ball Top



4005BT
3 1/4" x 54"



4040-48MS-BT
3 x 48"



4040BT
3" x 48"

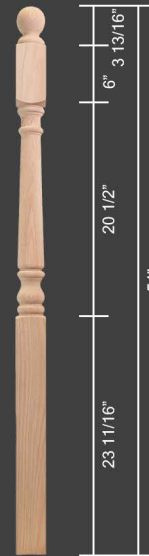

4042-54MS-BT
3" x 54"

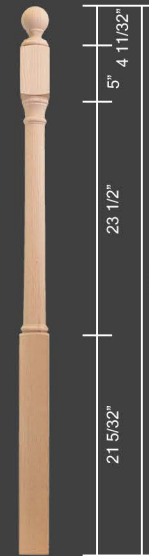

4042BT
3" x 54"

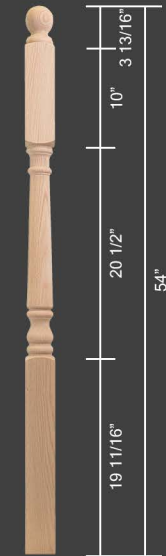

4043-54MS-BT
3" x 54"



4045-54MS-BT
3" x 54"

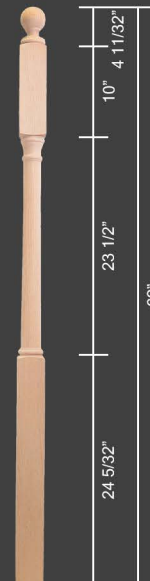

4045BT
3" x 62"

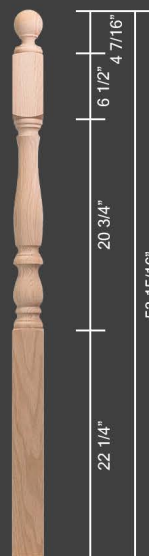

4160
3" x 54"



4170
3" x 54"



4301
3" x 54"

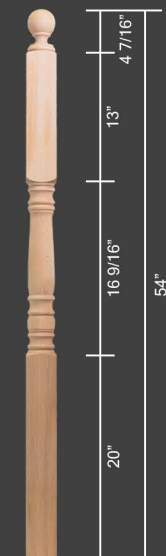

4305
3 x 54"

continue



4460
3 1/4" x 54"

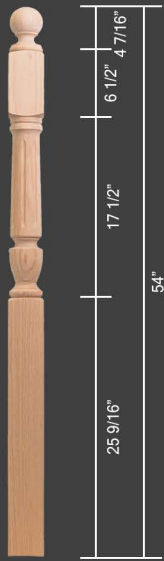

4465
3 1/4" x 54"



4470
3 1/4" x 54"



4475
3 1/4" x 54"



4501
3 1/4" x 54"



4505
3 1/4" x 54"



4640-48MS-BT
3 1/4" x 48"

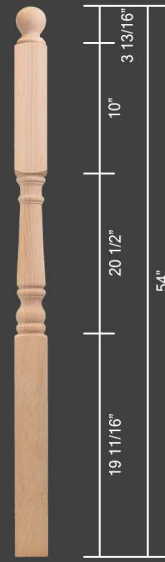

4643-54MS-BT
3 1/4" x 54"



4645-54MS-BT
3 1/4" x 54"

Mushroom Top



4040-48MS-6
3" x 48"



4042-54MS-6
3 x 54"



4042MT
3" x 54"

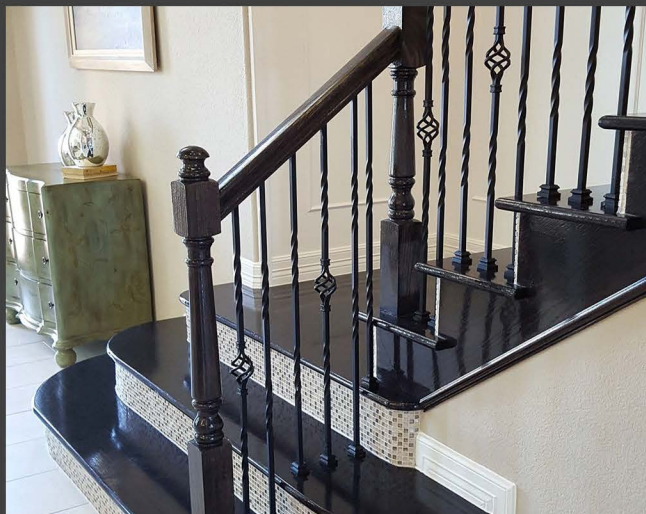
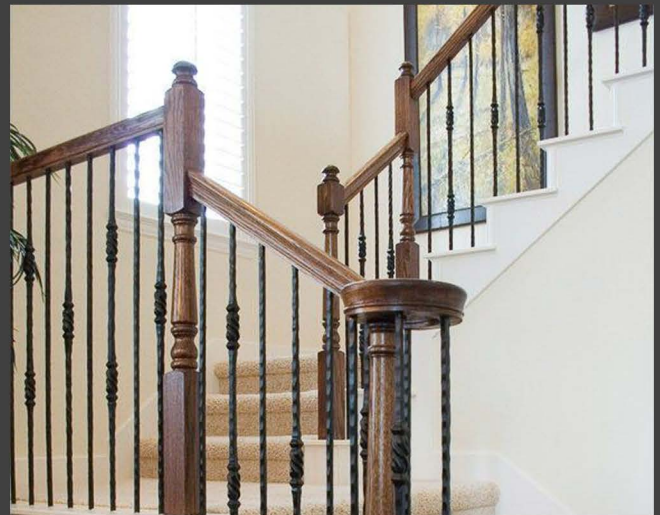

4043-54MS-10
3" x 54"

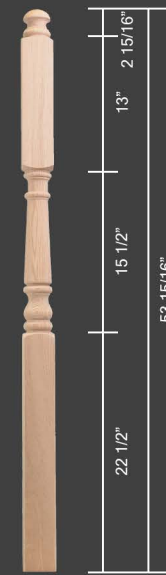

4045-54MS-13
3" x 54"

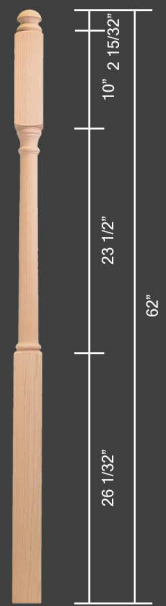

4045MT
3" x 62"

Pin Top



Pin Top Wood Newels connect to Wood Fittings, see Fittings page for selections.



4010-48MS
3" x 48"



4010PT
3 x 43"

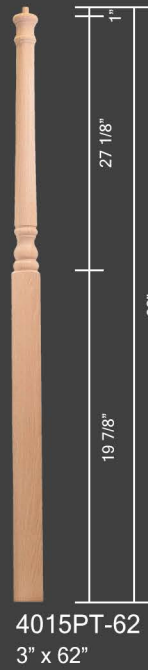

4015PT-62
3" x 62"

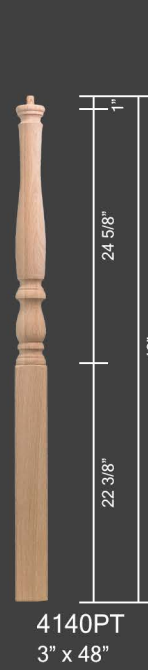

4140PT
3" x 48"

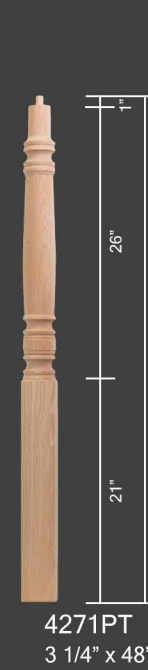

4271PT
3 1/4" x 48"



4410PT
3 1/4" x 48"



4411PT
3 1/4" x 48"



4444TW
3 1/4" x 48"

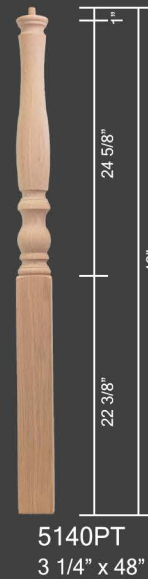

5140PT
3 1/4" x 48"



5145F
3 1/4" x 48"

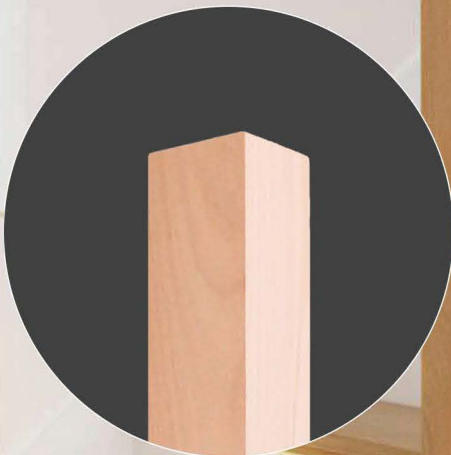

Blank

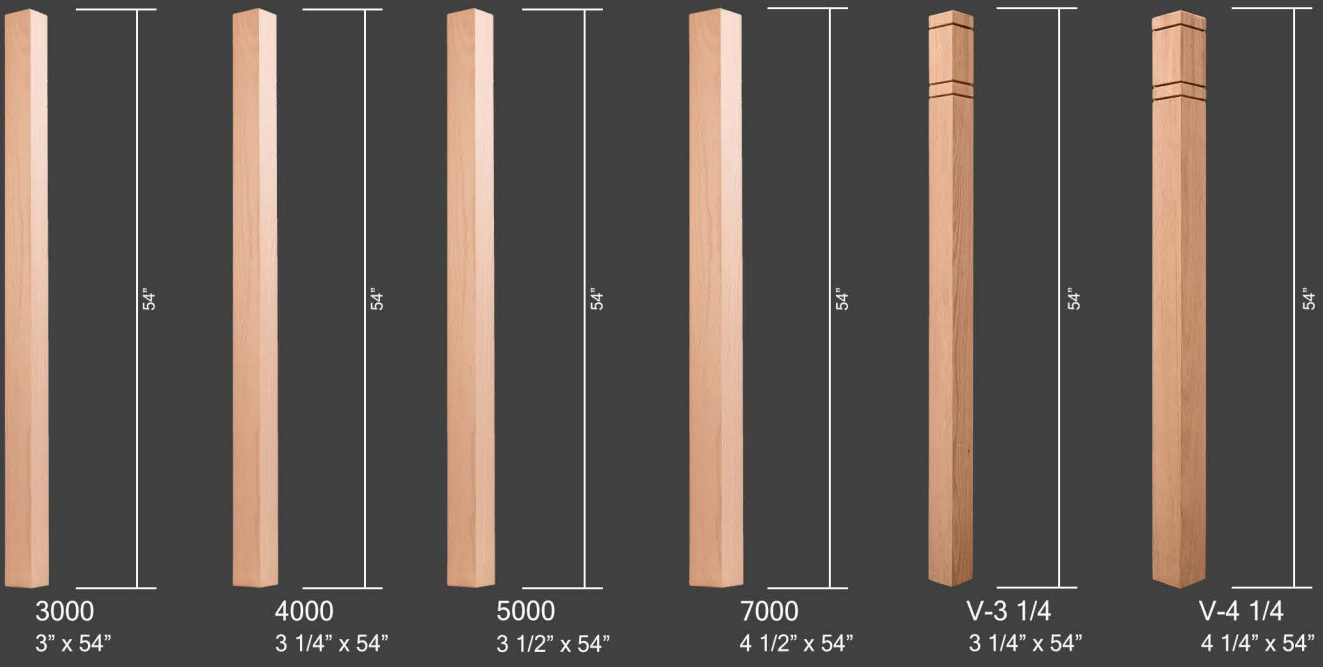

Stablizer Post

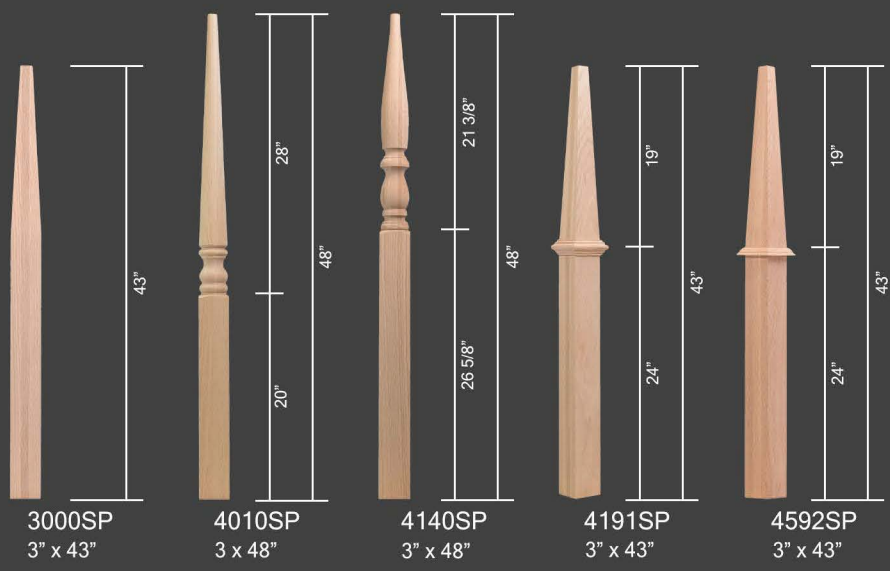



Box Newels



P - Plain
F - Fluted
RC - Recessed Panel
RP - Raised Panel



961
3 1/2" x 56"

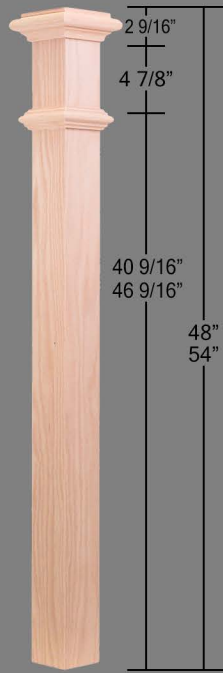

3092P
3 1/4" x 48"
3 1/4" x 54"

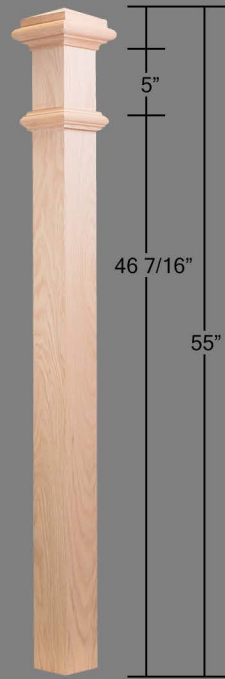

4075
3 1/2" x 55"



4091P
5 1/2" x 55 3/4"

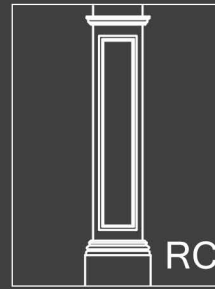
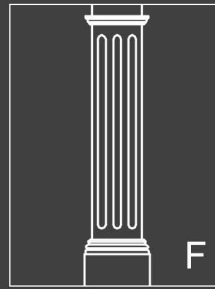
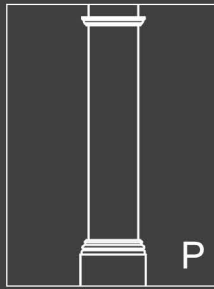

Box Newels



4291RC
6 1/4" x 55"



4291RP
6 1/4" x 55"

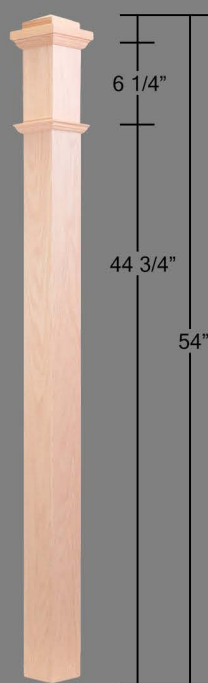

4592P
3 1/2" x 54"

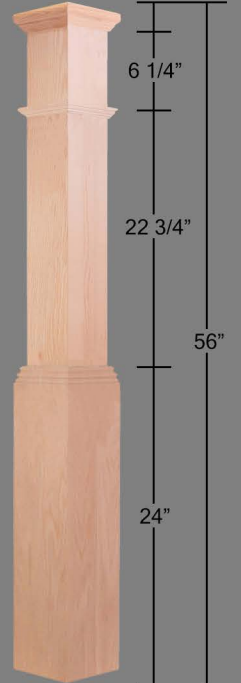

4691P
6 1/4" x 56"



4092RC
6" x 55 1/2"

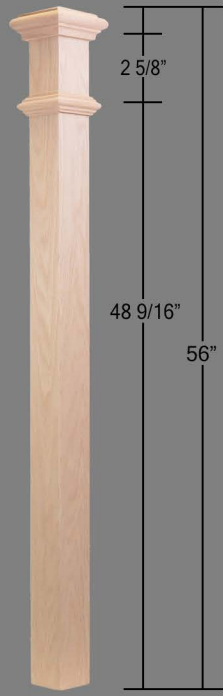

4191P
3 1/4" x 56"



4291F
6 1/2" x 55"



4291P
6 1/4" x 55"

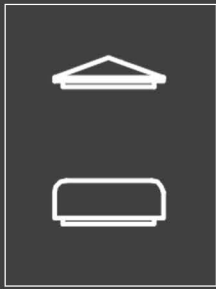

continue



4692
5" x 56"



Base
5" x 25 3/8"



4791RP
6 1/4" x 56"



4891F
6 1/4" x 56"



4991RC
6 1/4" x 56"







Wood Fittings

Wood Fittings

70 series fittings match with 6010 rail; 72 series refer to 6210 rail; and 77 series work with 6710 rail.



Red Oak











White Oak



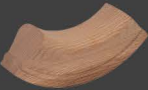

Maple



	6002	6010	6210	6710	6040
		7009	7209		
		7010	7210	7710	
		7011	7211	7711	
		7012	7212	7712	
		7013	7213	7713	
		7014	7214	7714	
		7015	7215	7715	
		7016	7216	7716	
		7019	7219	7719	

continue



	6002	6010	6210	6710	6040
		7020	7220	7720	
		7021	7221	7721	
		7030	7230	7730	
		7035	7235	7735	
		7031	7231	7731	
		7036	7236	7736	
		7040	7240	7740	
		7045	7245	7745	
		7041	7241	7741	
		7046	7246	7746	

continue



	6002	6010	6210	6710	6040
Left Hand Riser		7050	7250	7750	
Left Hand Riser		7060	7260	7760	
Right Hand Riser		7065	7265	7765	
Left Hand Riser		7070	7270	7770	
Right Hand Riser		7075	7275	7775	
Left Hand Riser		7071	7271	7771	
Right Hand Riser		7076	7276	7776	
Left Hand Riser		7081	7281	7781	
Right Hand Riser		7086	7286	7786	
2 Riser with Tandem Cap		7088-2	7288-2	7788-2	

continue



	6002	6010	6210	6710	6040
 Left Hand Riser		7090	7290	7790	
 Right Hand Riser		7095	7295	7795	
 Left Hand Riser		7090-2	7290-2	7790-2	
 Right Hand Riser		7095-2	7295-2	7795-2	
 2 Riser with Cap		7097	7297	7797	
 Riser without Cap		7098	7298	7798	
 2 Riser without Cap		7099	7299	7799	
 Up Easing			7212-12		
 Over Easing			7213-12		

Wood Fittings

60 series



Red Oak











White Oak

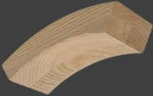

Maple



		6002	6010	6210	6710	6040
	Quarterturn 90°	6002-11				
	Up Easing	6002-12				
	Over Easing	6002-13				
	Opening Cap	6002-19				
	Tandem Cap	6002-20				
	Quarterturn Cap 90°	6002-21				
	Left Hand Volute	6002-30				
	Right Hand Volute	6002-35				
	Left Hand Turnout	6002-40				

continue



	6002	6010	6210	6710	6040
Right Hand Volute	6002-45				
Quarterturn 90°					6040-11
Up Easing					6040-12





Wood Handrails

Handrails - Straight



Red Oak



White Oak



Maple



Hickory

Handrails are available in Red Oak, White Oak, Maple, and Hickory. Most rails are available in 16 ft and 20 ft. Some may sell in linear footages, based on your design and measurement needs. Consult with our experienced sales representatives for more information.

469.453.6744

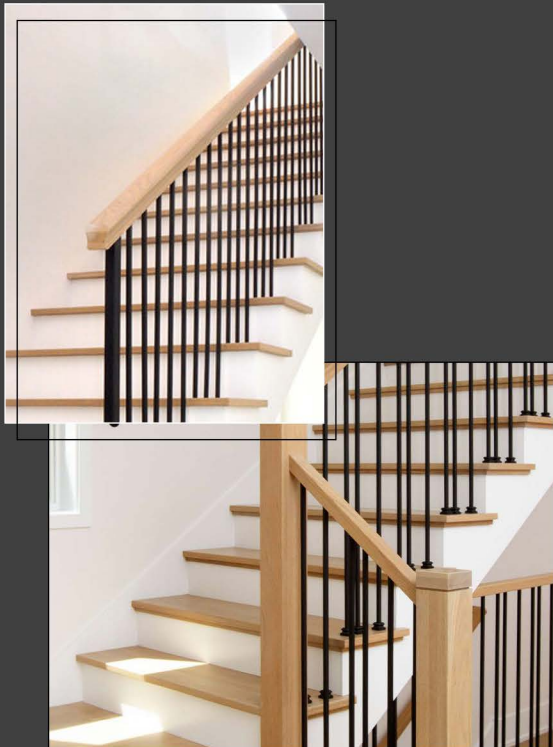

6010

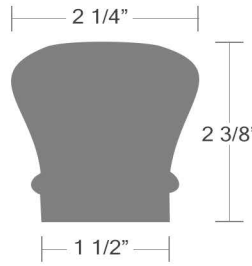

6210

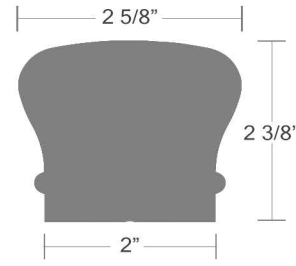

6710

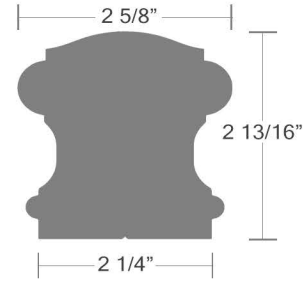

6001
Modern Square
1 1/4" x 2 1/4"

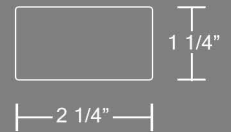

6002
Modern Square
1 5/8" x 2 3/4"

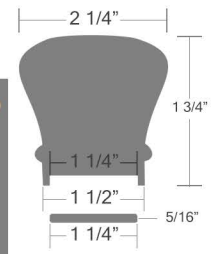
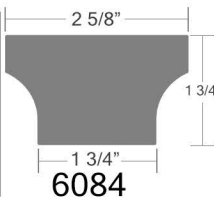
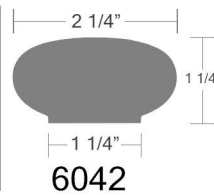
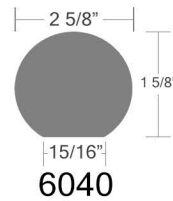

6010-P

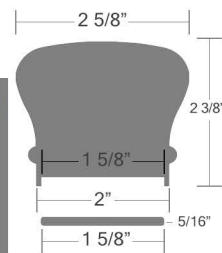

6210-P

Handrails - Bending

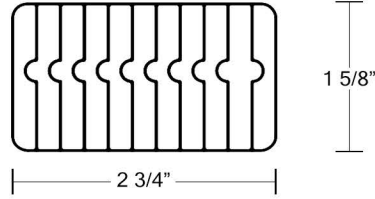
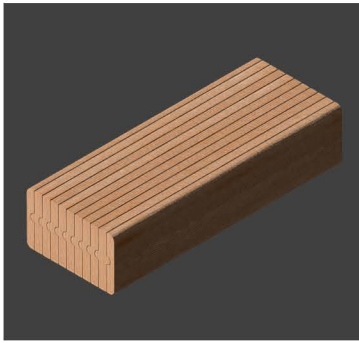

6002B

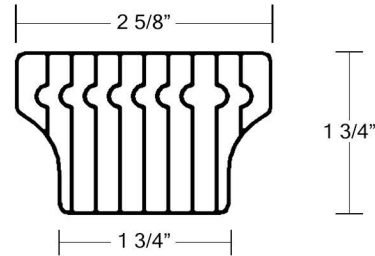
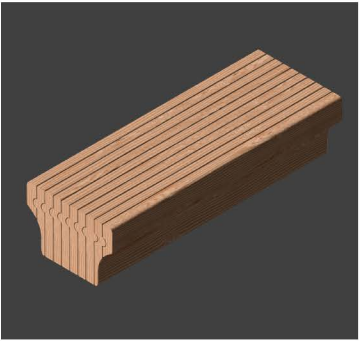

6084B



6010B



6210B

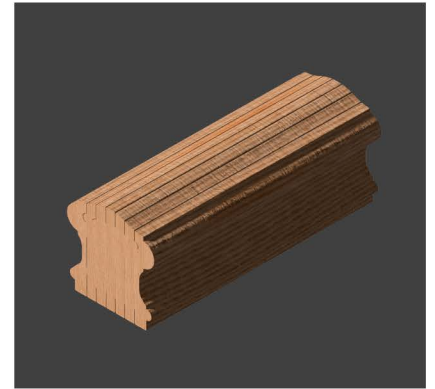

6710B

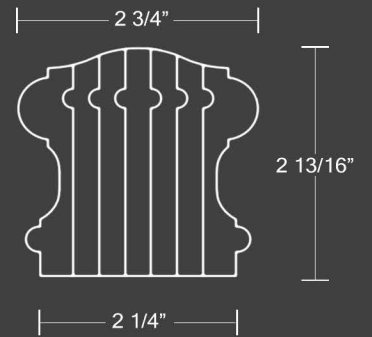
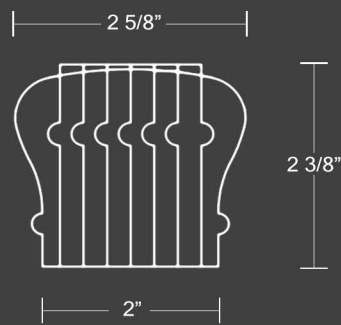
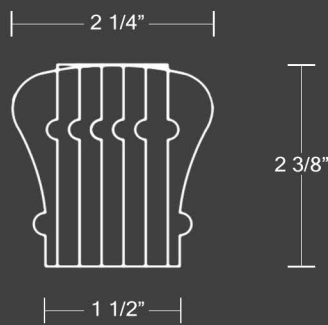

**INTERNATIONAL
STAIR PRODUCTS INC**





Starter Steps



8011

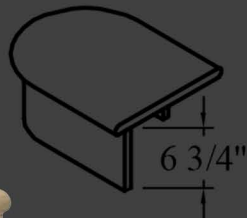

8012

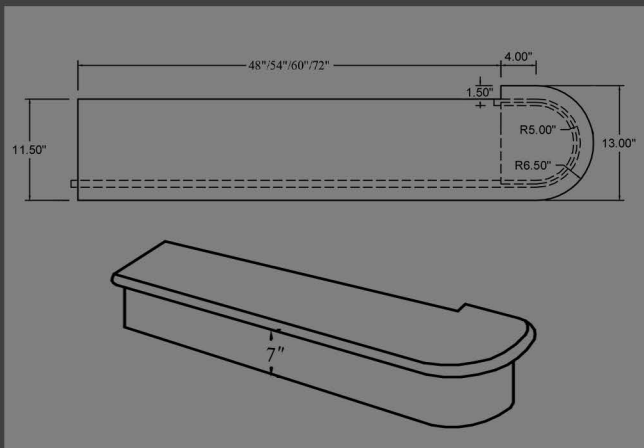
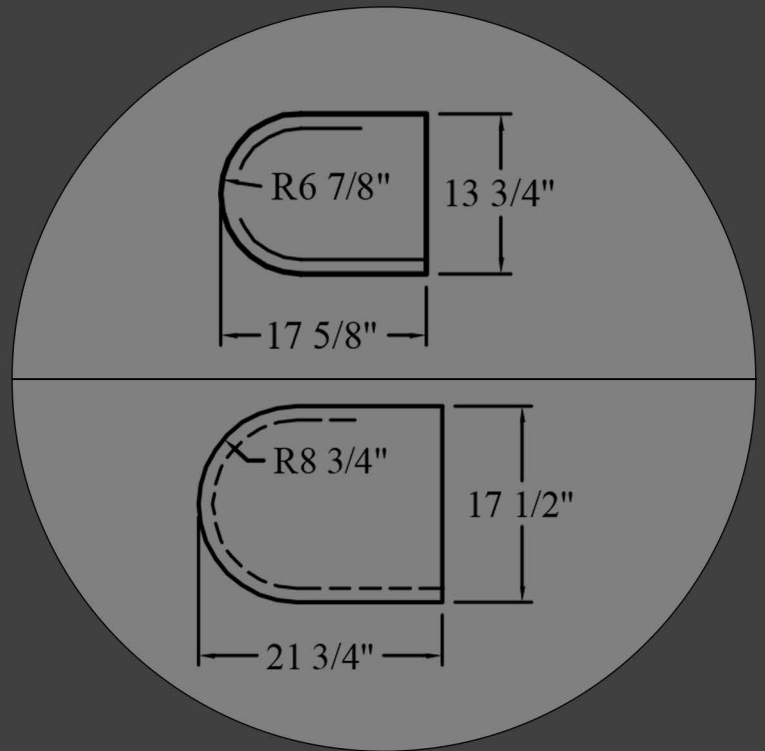

8010



Necessary coves and shoe mouldings are included within the matching starter steps.



8015

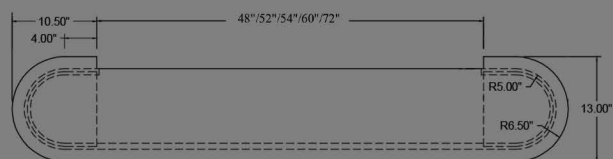
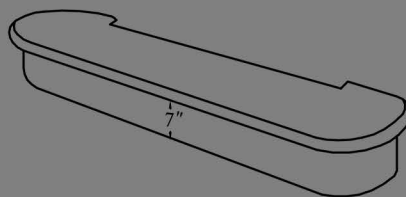

8650

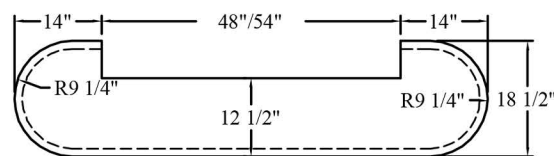
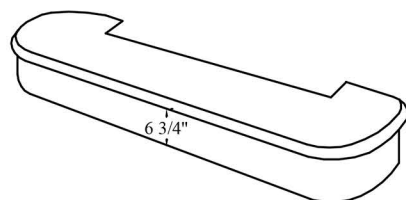

8915

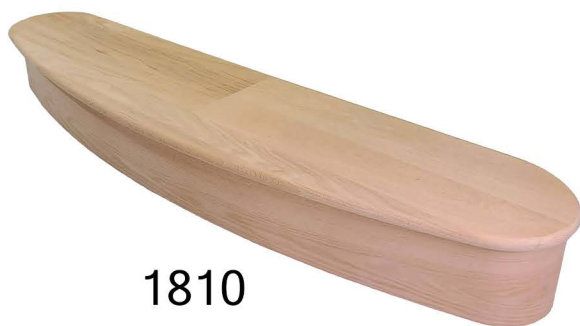
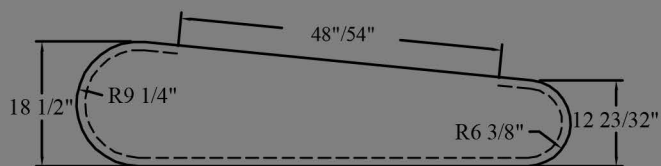
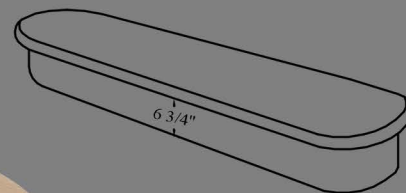

1810

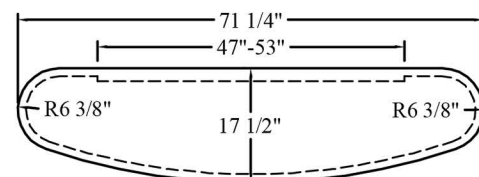
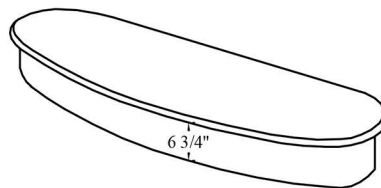



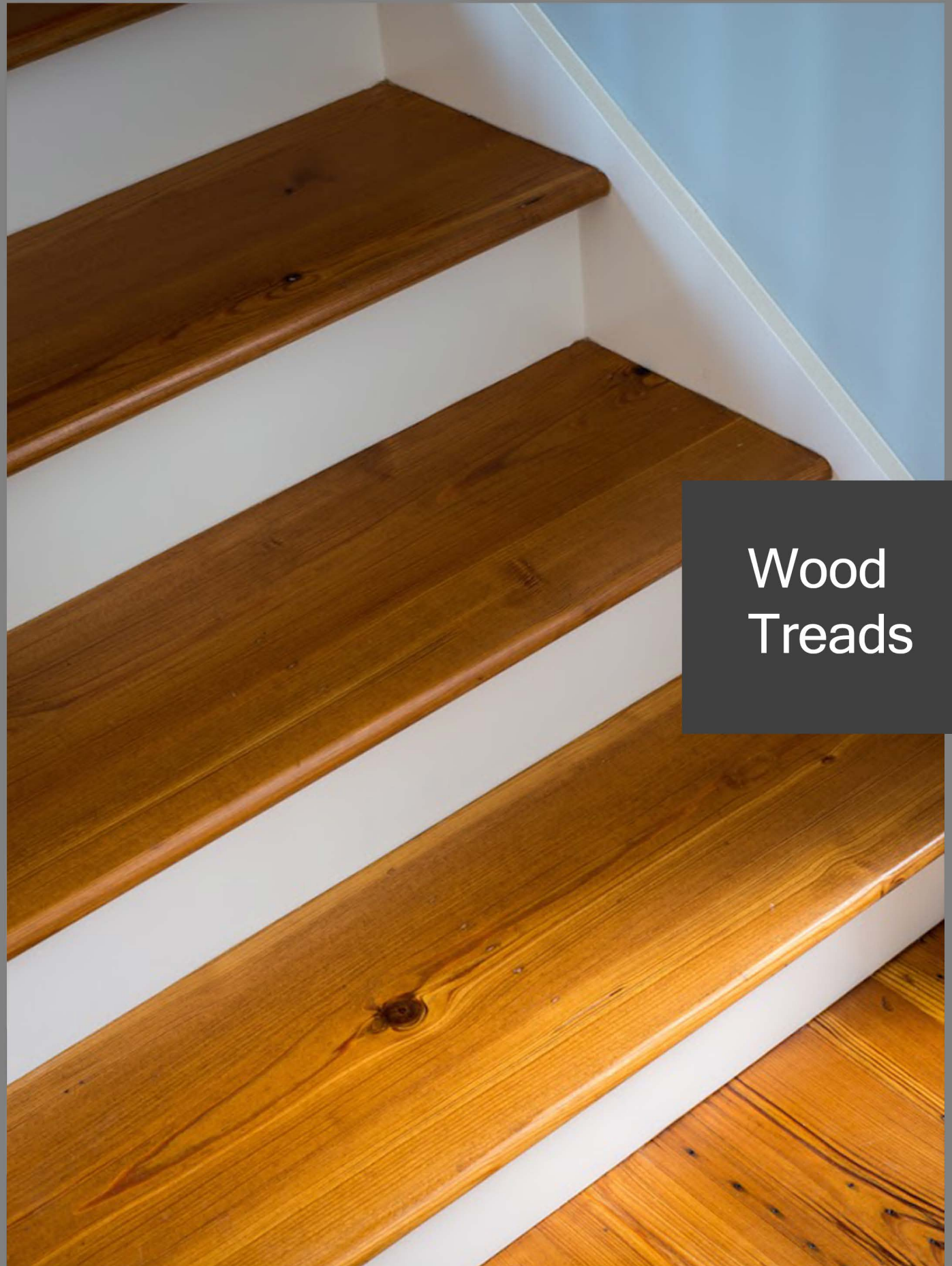

Wood Treads



In Stock:
42", 48", 54", 60", 72".

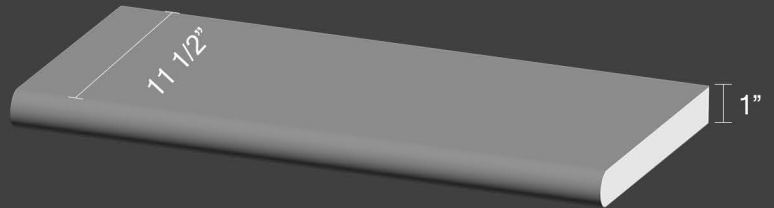

In Stock:
42", 48", 54", 60", 72", 96".

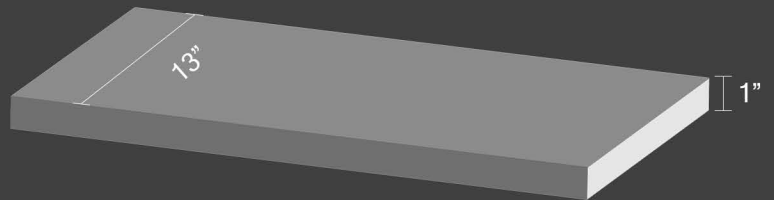

*We stock with 24"x60" and 30"x60" in both Red Oak and White Oak.

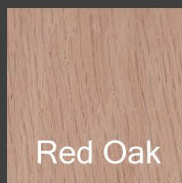

Red Oak



White Oak

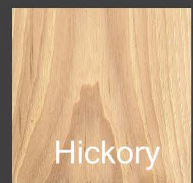

Hickory

S4S Boards & Sheets



Red Oak



White Oak



MDF



Hickory



Maple



Poplar

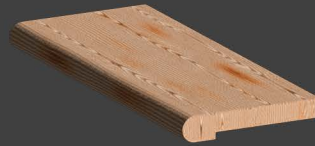

Landing Treads



Riser 1 x 8



Riser 1 x 12



Plywood Sheet
4' x 8'

MDF Boards
16'

1" x 8"

1" x 12"



Red Oak 1/4"



White Oak 1/4"



Red Oak 3/4"



White Oak 3/4"



MDF 1/4"



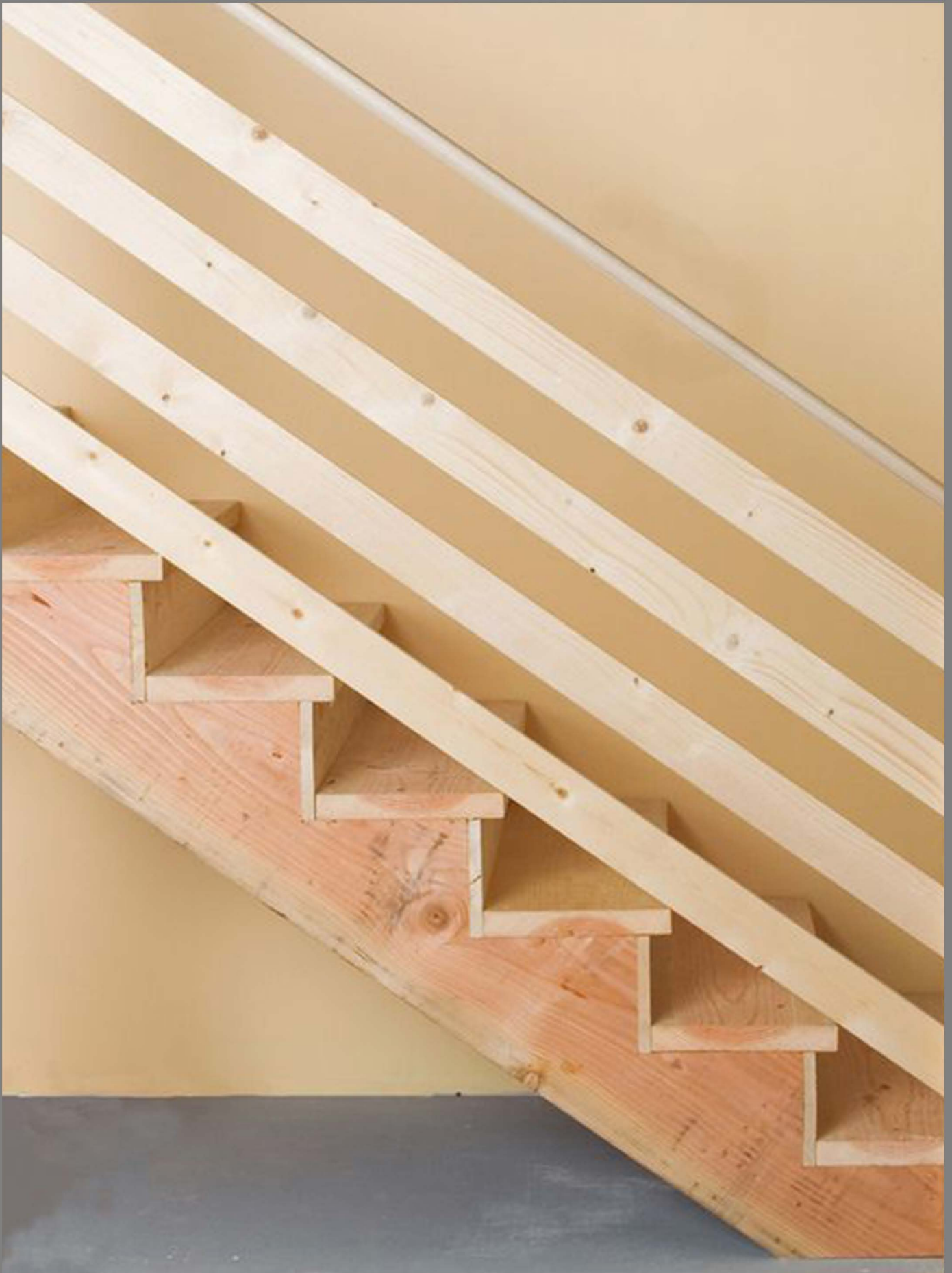



Cove & Trim

Coves and Trims provide finishing touches to create a richly decorated stairway that you and your family will cherish.

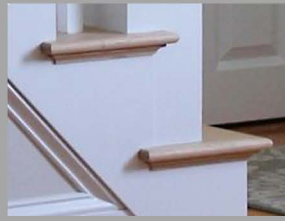

Red Oak



White Oak



Hickory



Paint Grade



Walnut

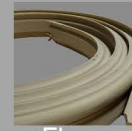

Flex -
Wood Grain

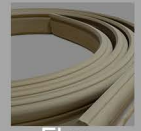

Flex -
Paint Grade



8060



8064



8065



6007



6050



PM1



PM2



PM5



PM6



DM7



C322



Shoe
Mould





Iron Collection

Metal Finishes Guide



Satin Black



Ash Grey



Oil Rubbed Bronze



Oil Rubbed Copper

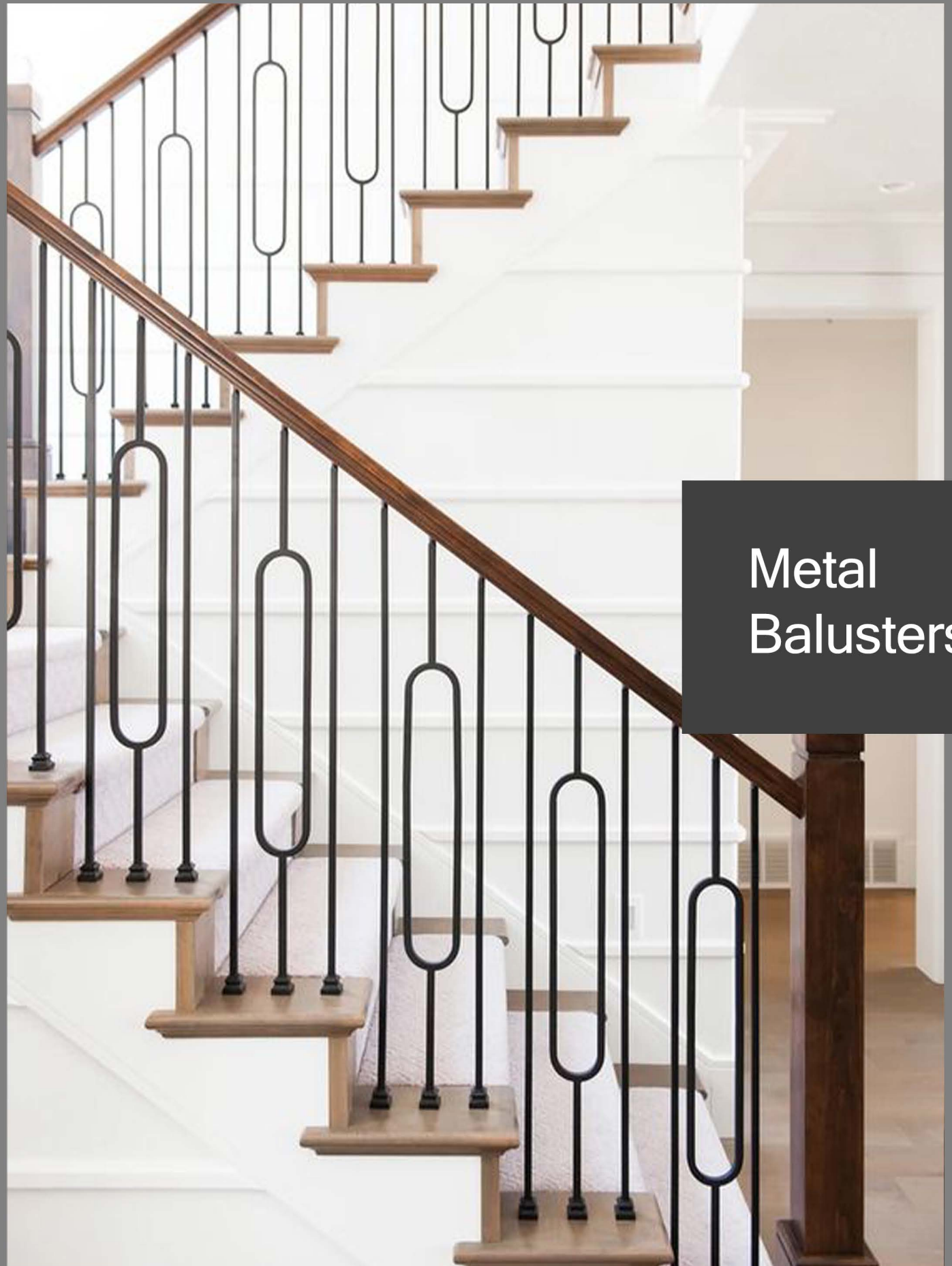

Metal Balusters

Modern Series



Satin Black



Ash Grey



Oil Rubbed Bronze



Oil Rubbed Copper



ISP 6.1



ISP 6.2

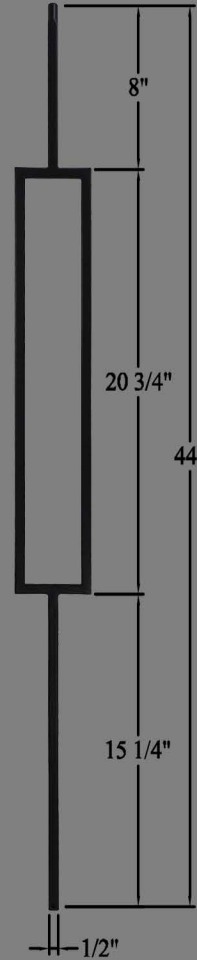

ISP 6.3

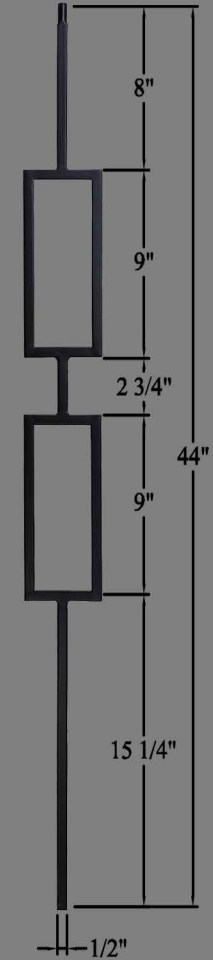

ISP 6.4

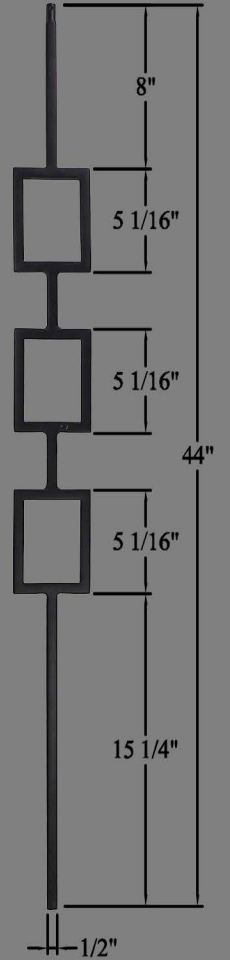

ISP 6.5



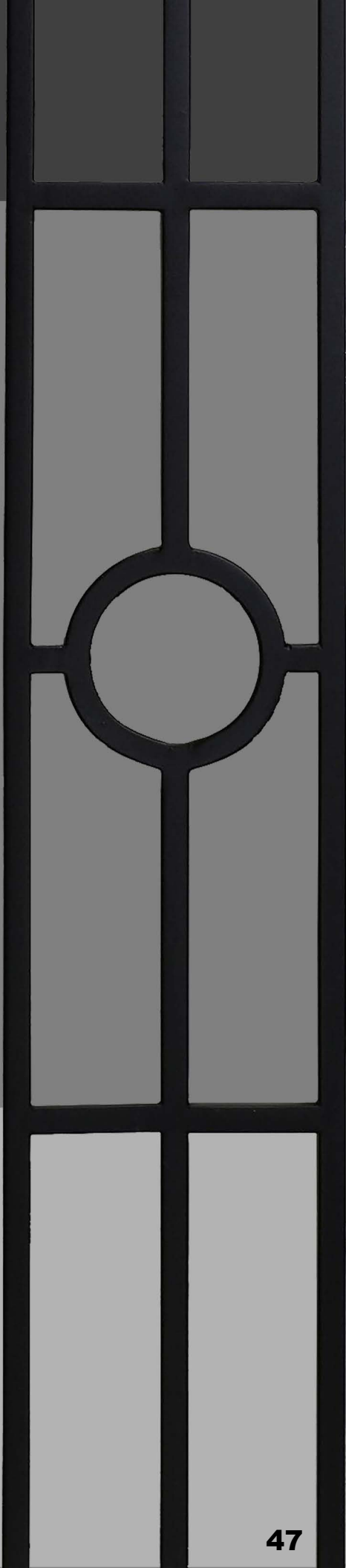
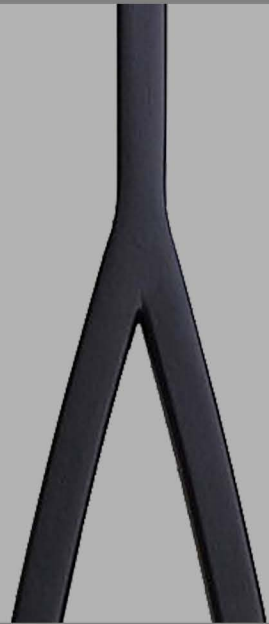
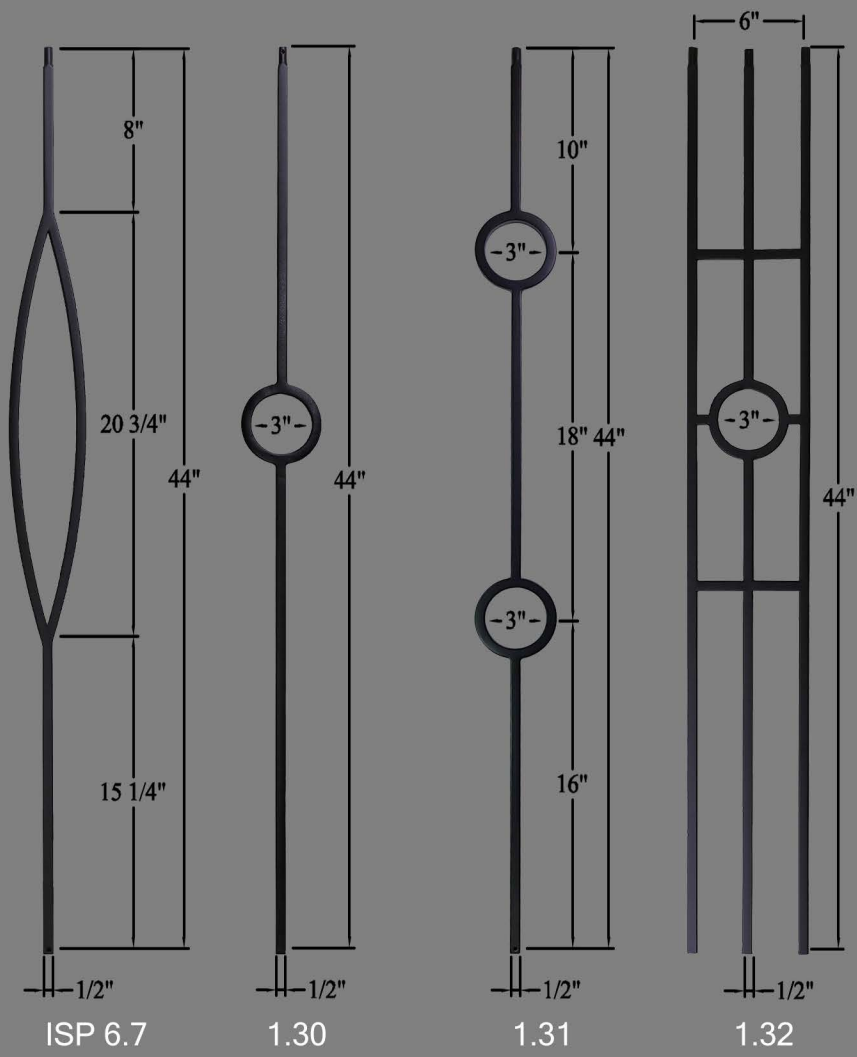

Versatile Series

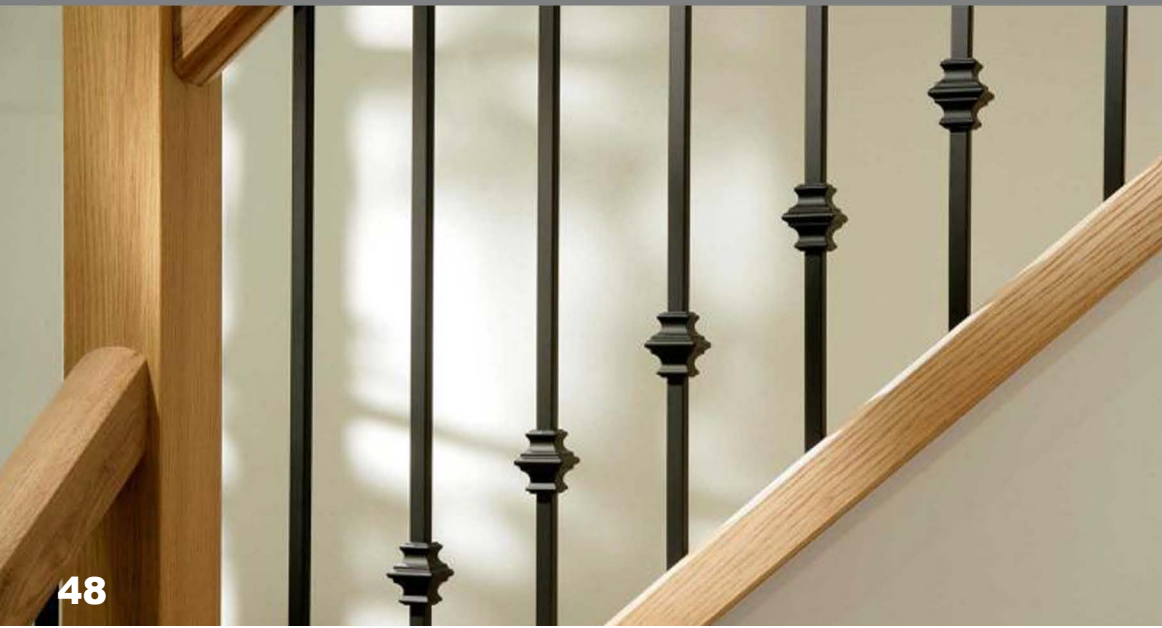
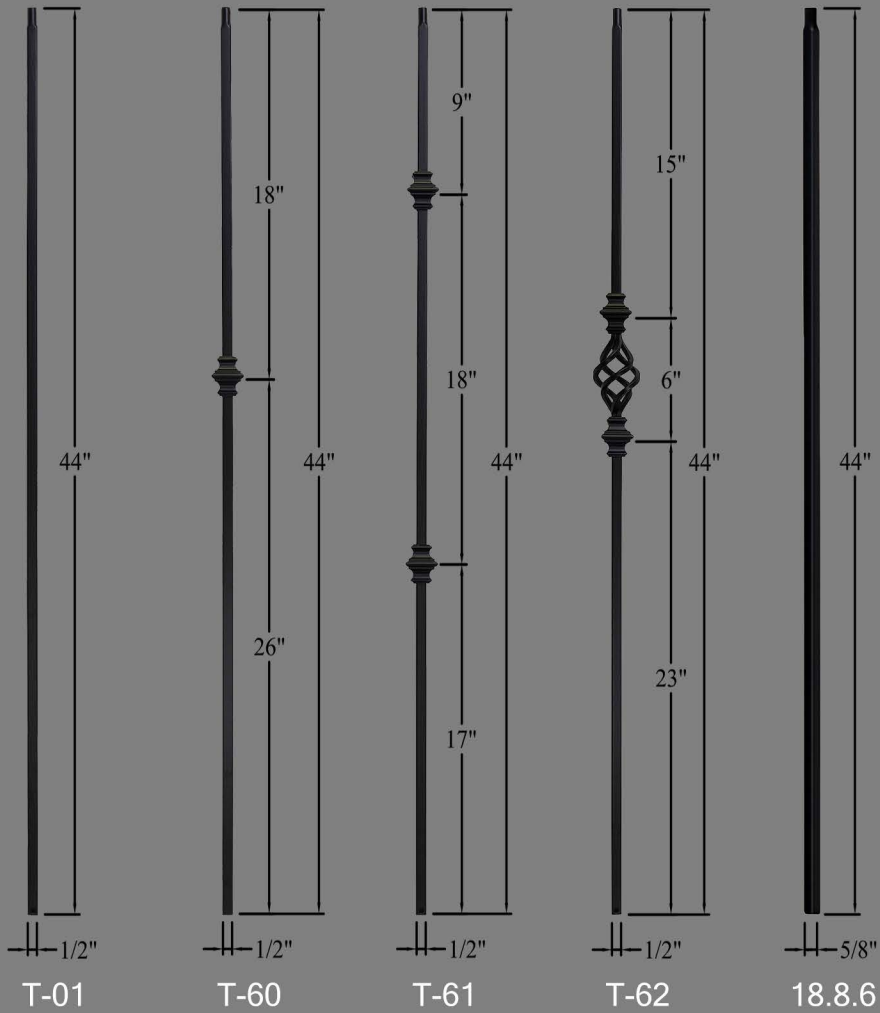

Twist & Basket



Satin Black



Ash Grey



Oil Rubbed Bronze



Oil Rubbed Copper



T-02

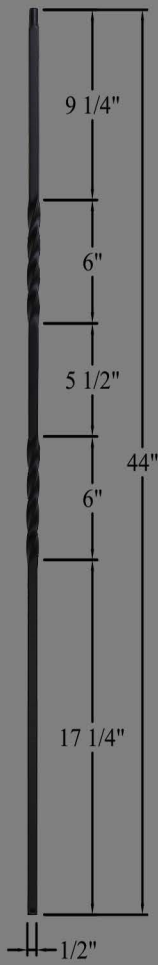

T-03



T-04



T-05

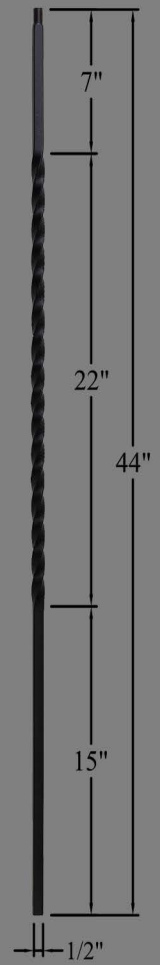

1.21



Round Series



Satin Black



Ash Grey



Oil Rubbed Bronze



Oil Rubbed Copper

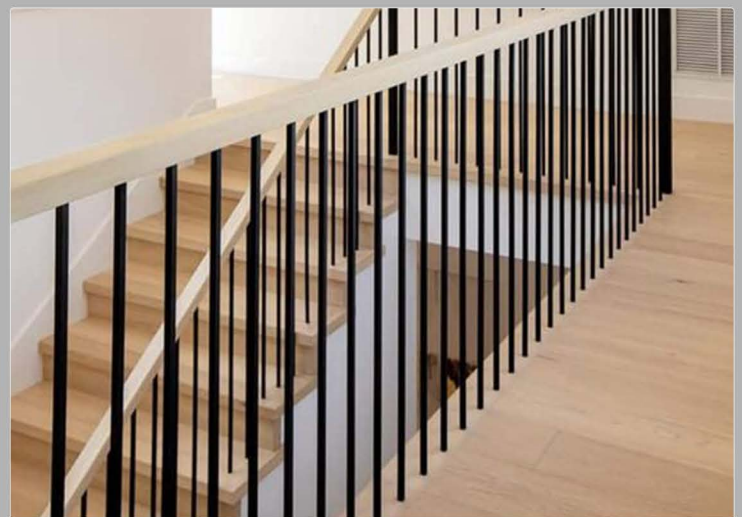
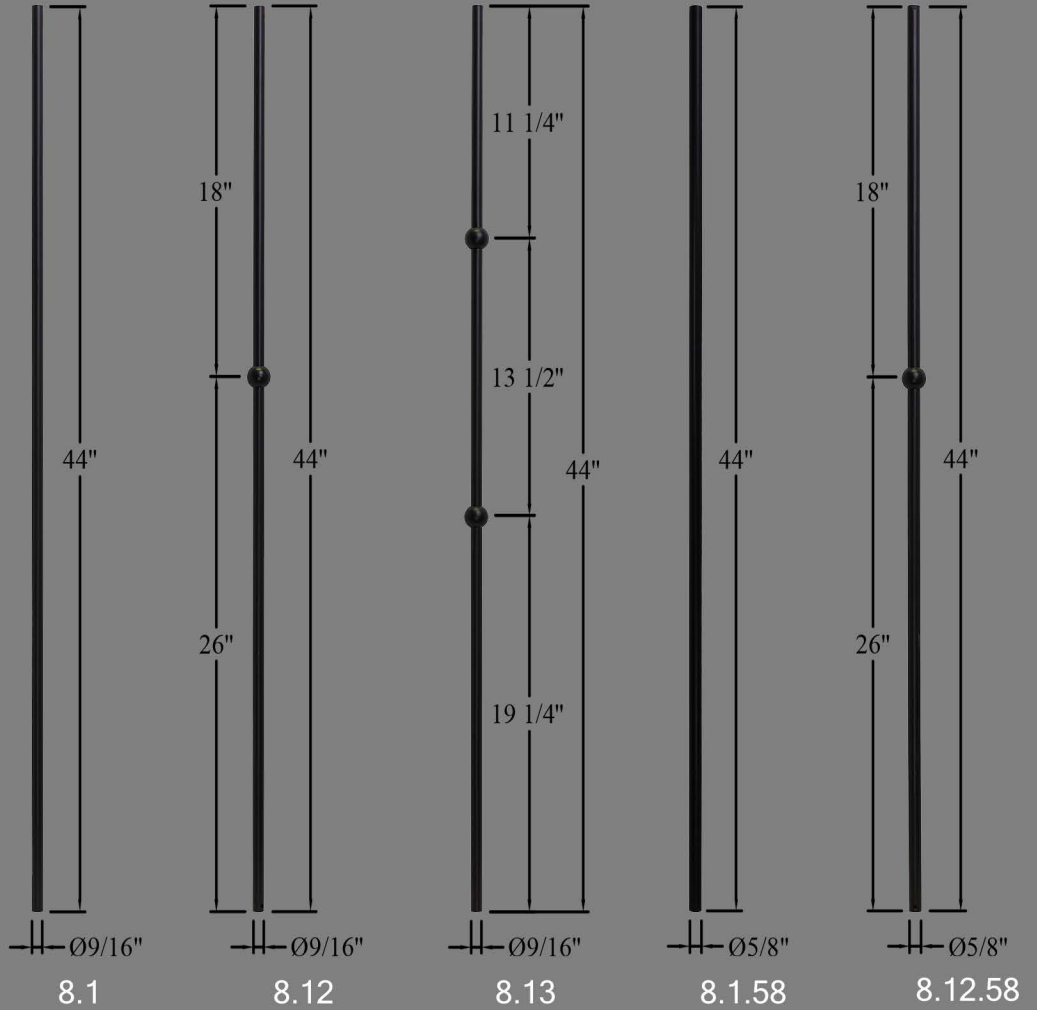



8.13.58



2.11.3



2.11.4



2.11.16



Ribbon Series



Scroll Series

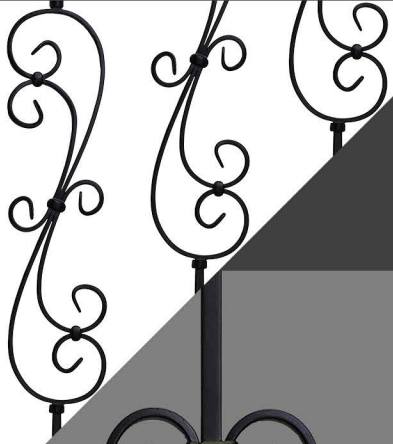

T-56

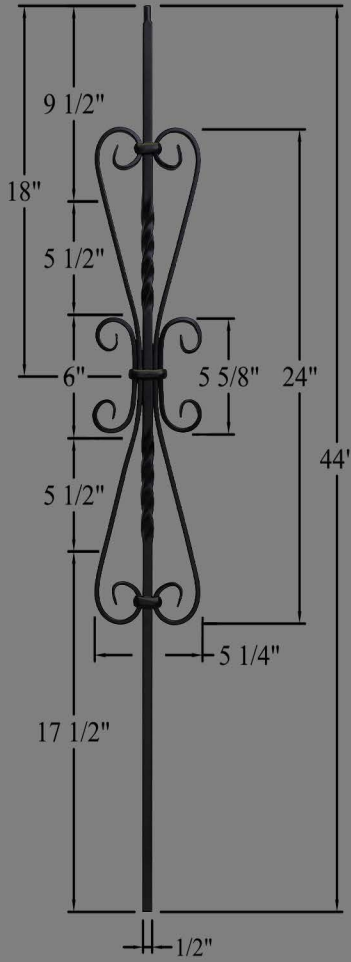

1.41

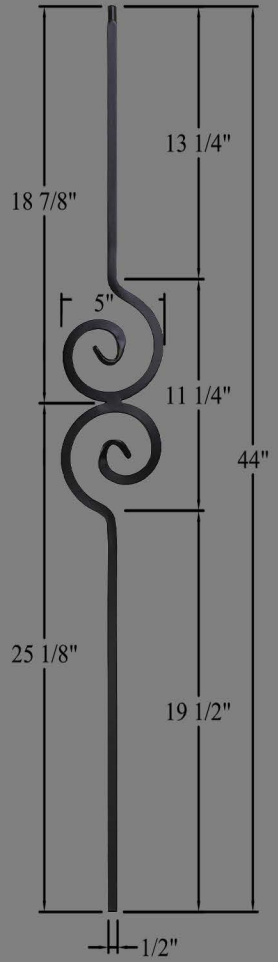

2.10.1

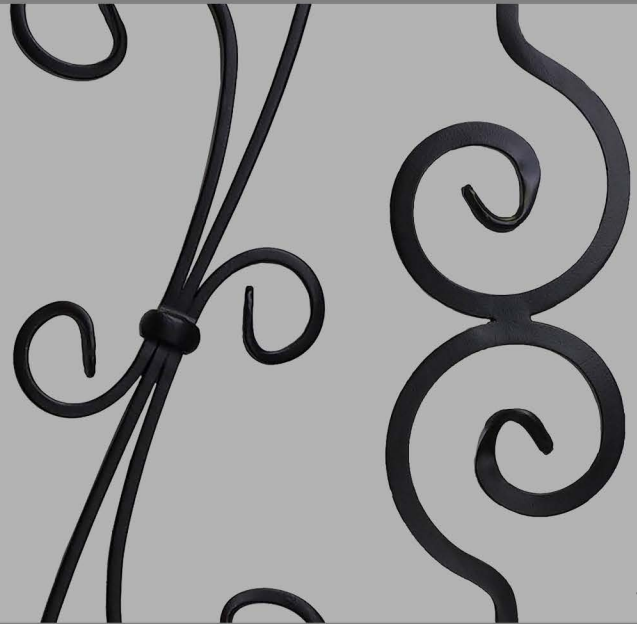
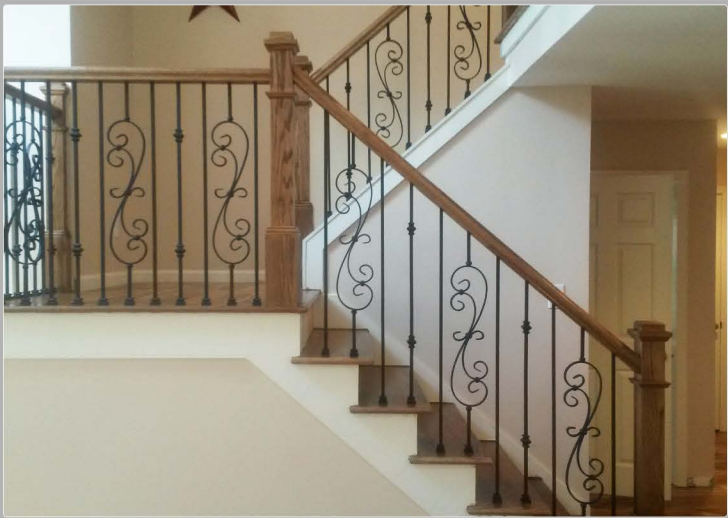

Belly Series

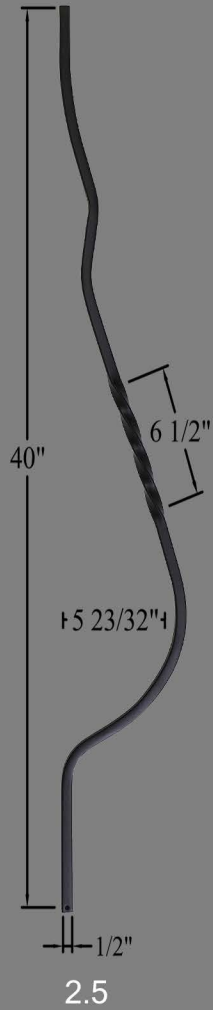
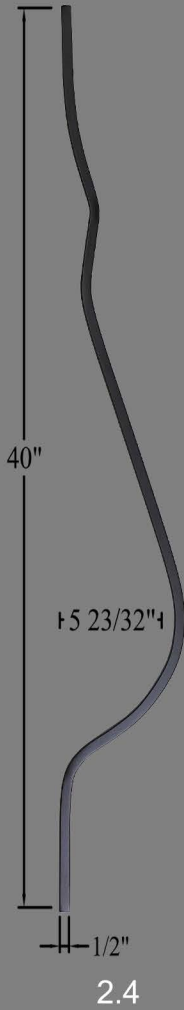

Gothic Series



T-41HF



T-42HF



T-43HF

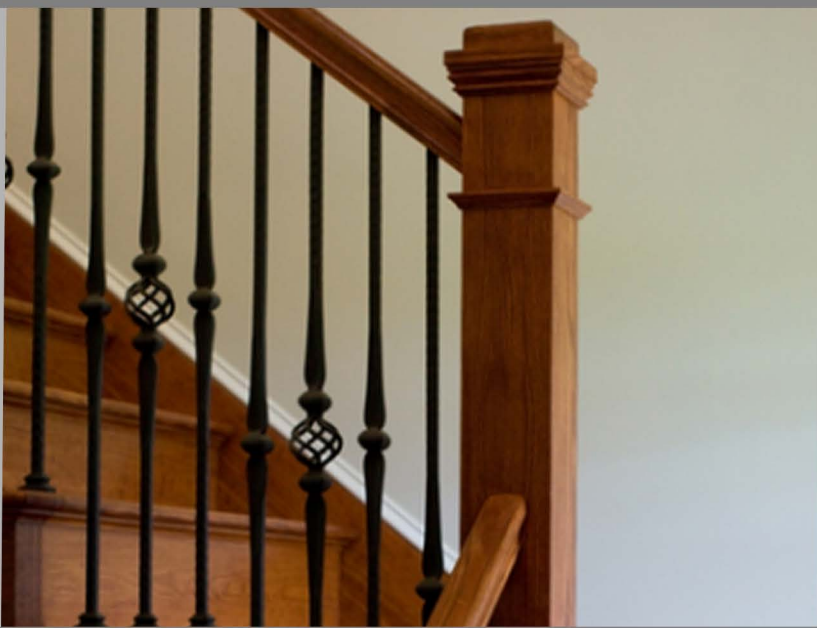

Round Hammered

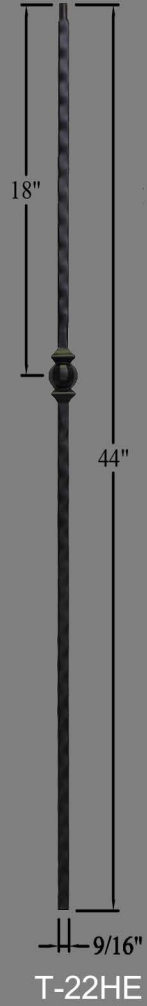

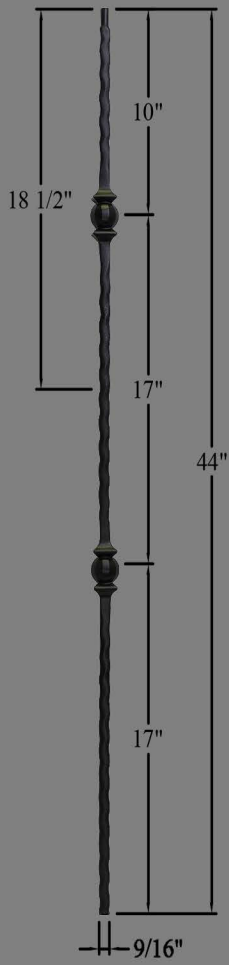

T-23HE



T-24HE

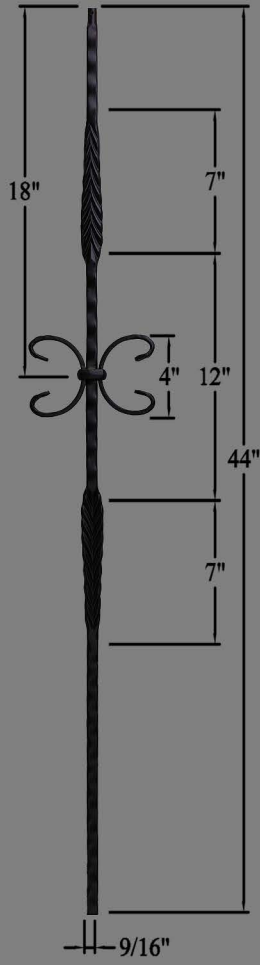

T-26HE

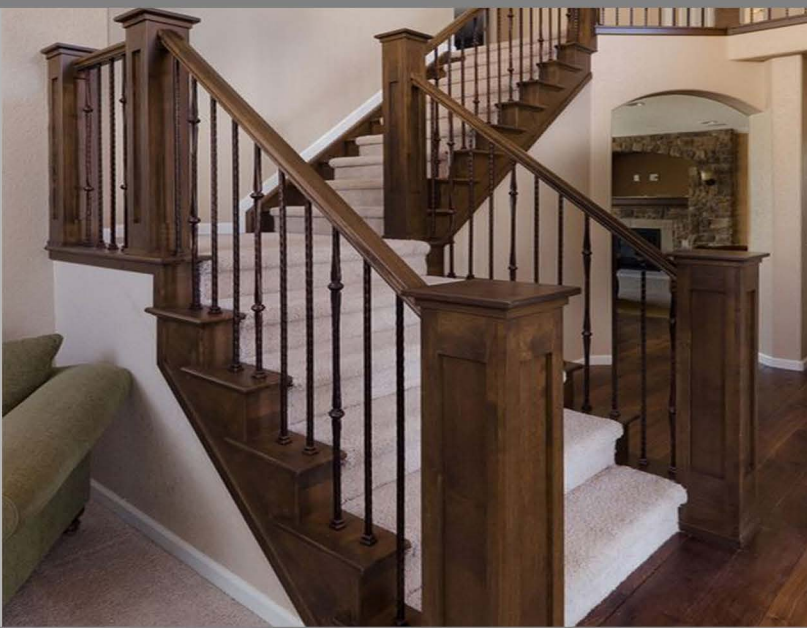

Square Hammered



Satin Black

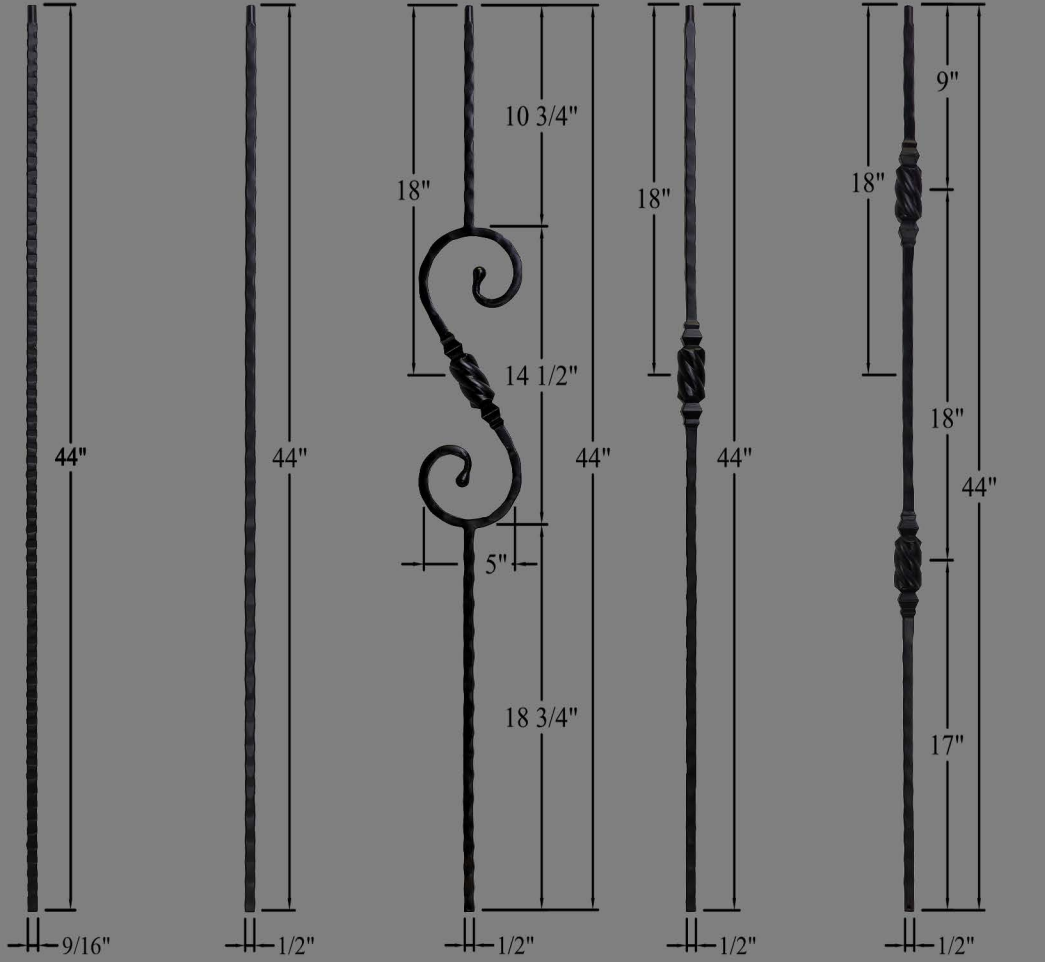
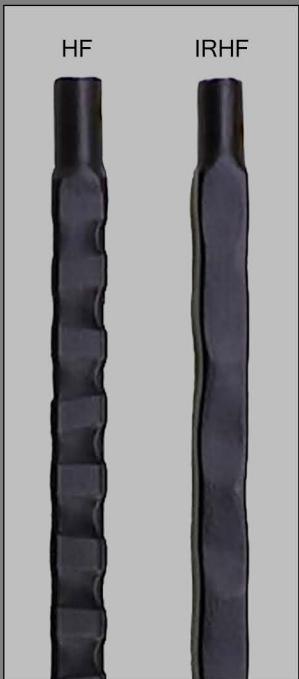

T-01HF

T-01IRHF

T-55IRHF

T-64IRHF

T-65IRHF





T-66IRHF

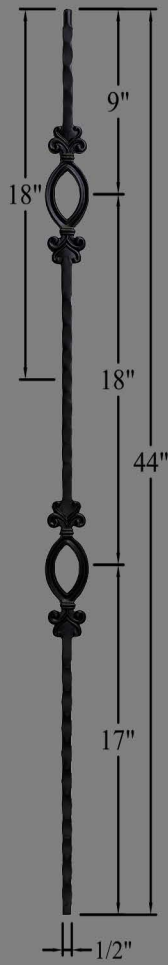

T-67IRHF



T-68IRHF



T-69IRHF

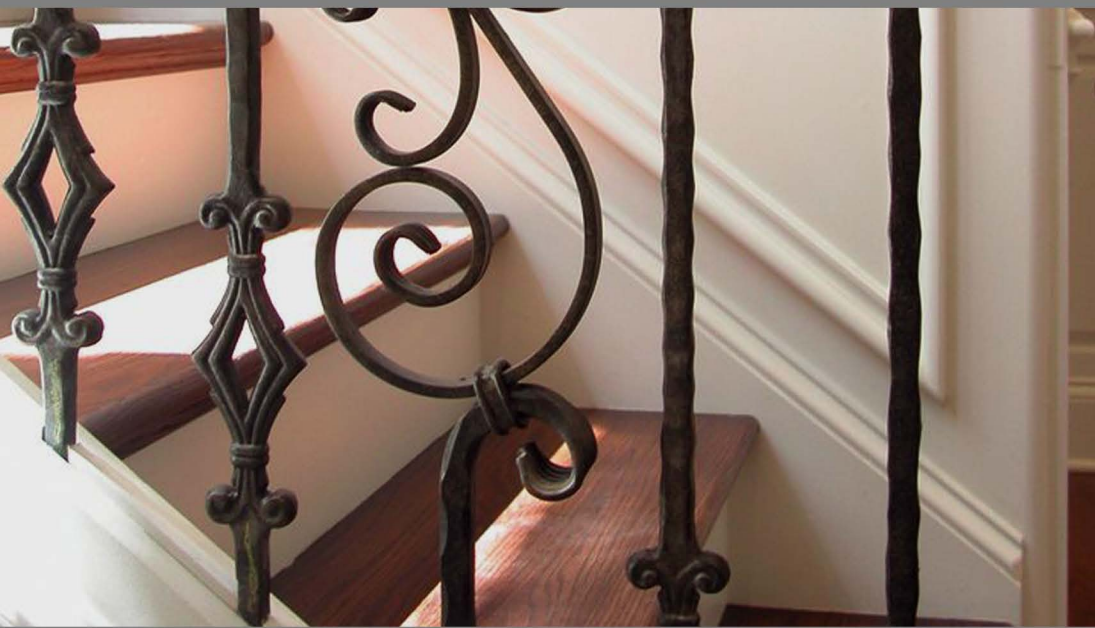

Venetian Series

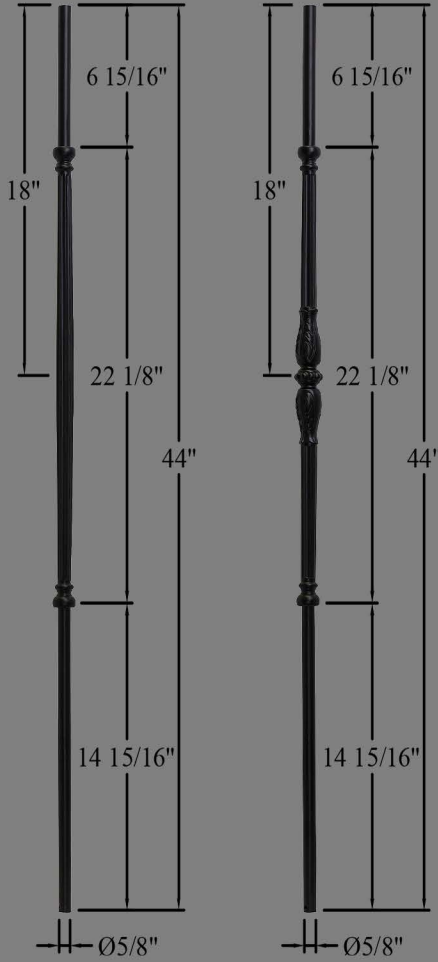

RT-44

RT-45



Solid Balusters



A-01

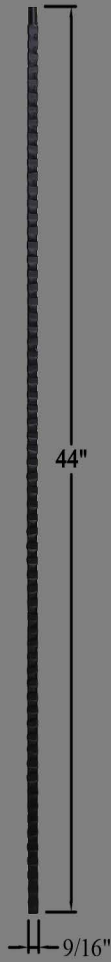

A-01HF



A-41HF



A-42HF



A-43HF

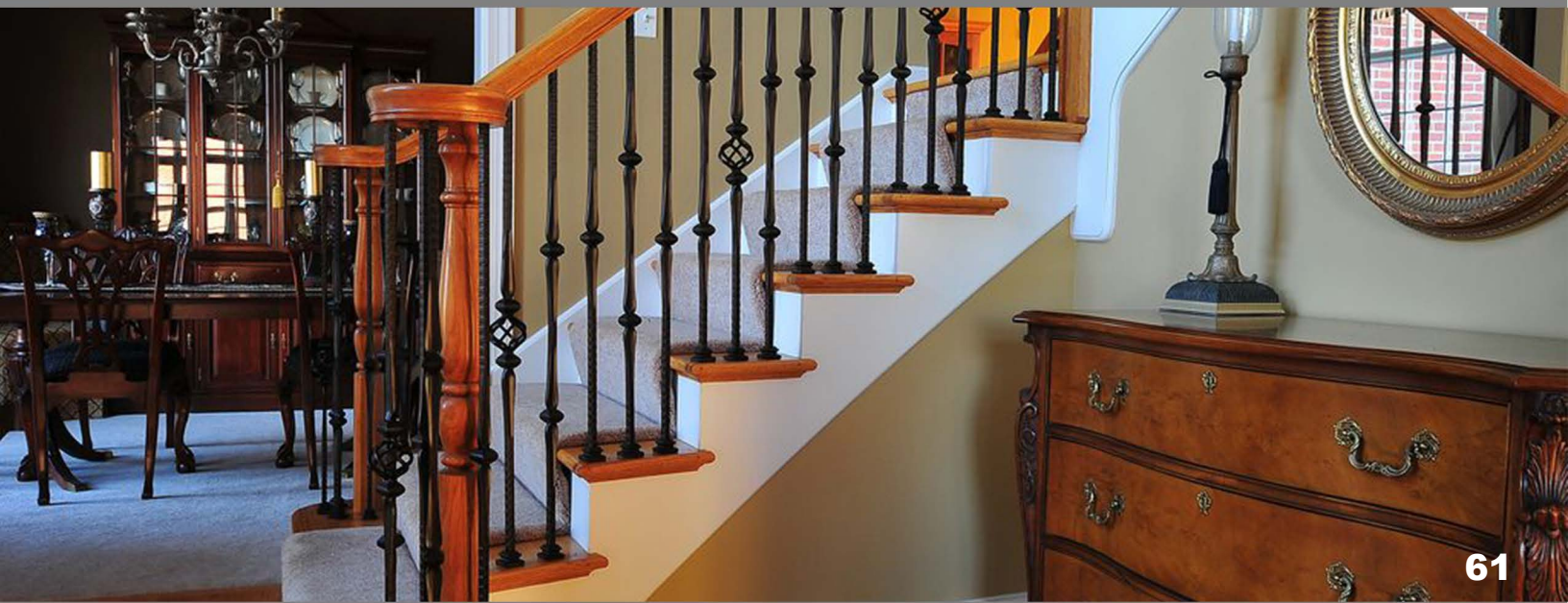

Mega Series



MGPLA44



MG1KNUC44

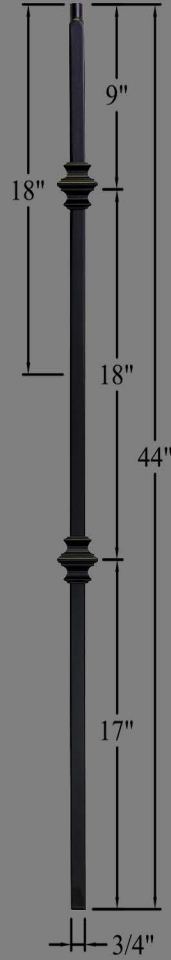

MG2KNUC44

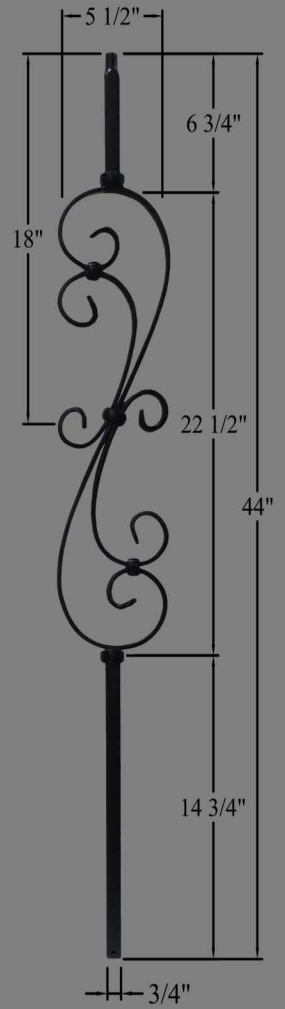

MG16044

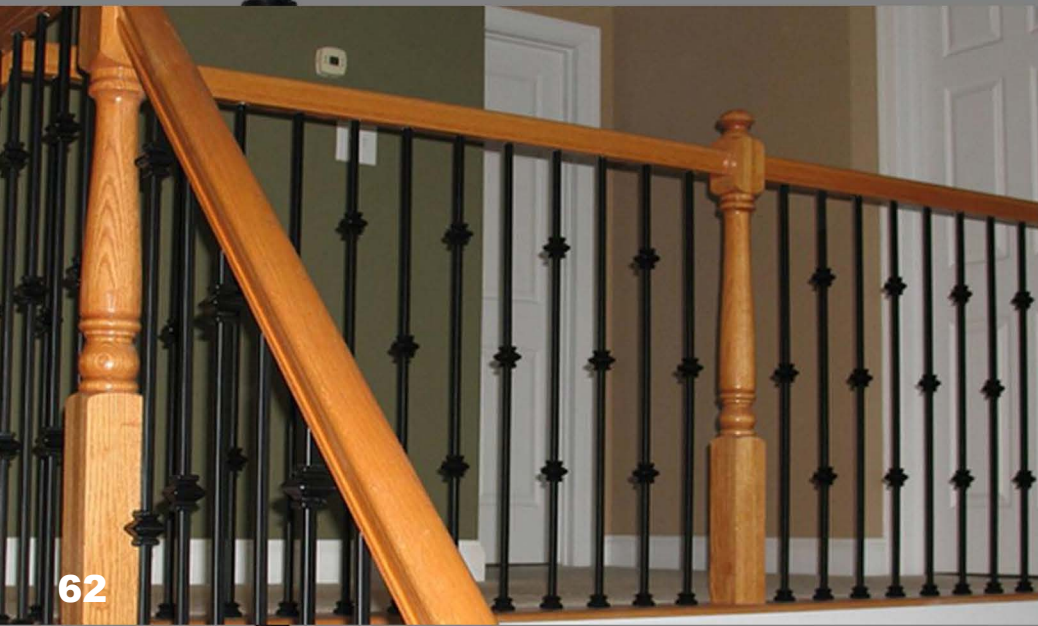



MG1TW44



MG2TW44



MG1BASK44



MG2BASK44

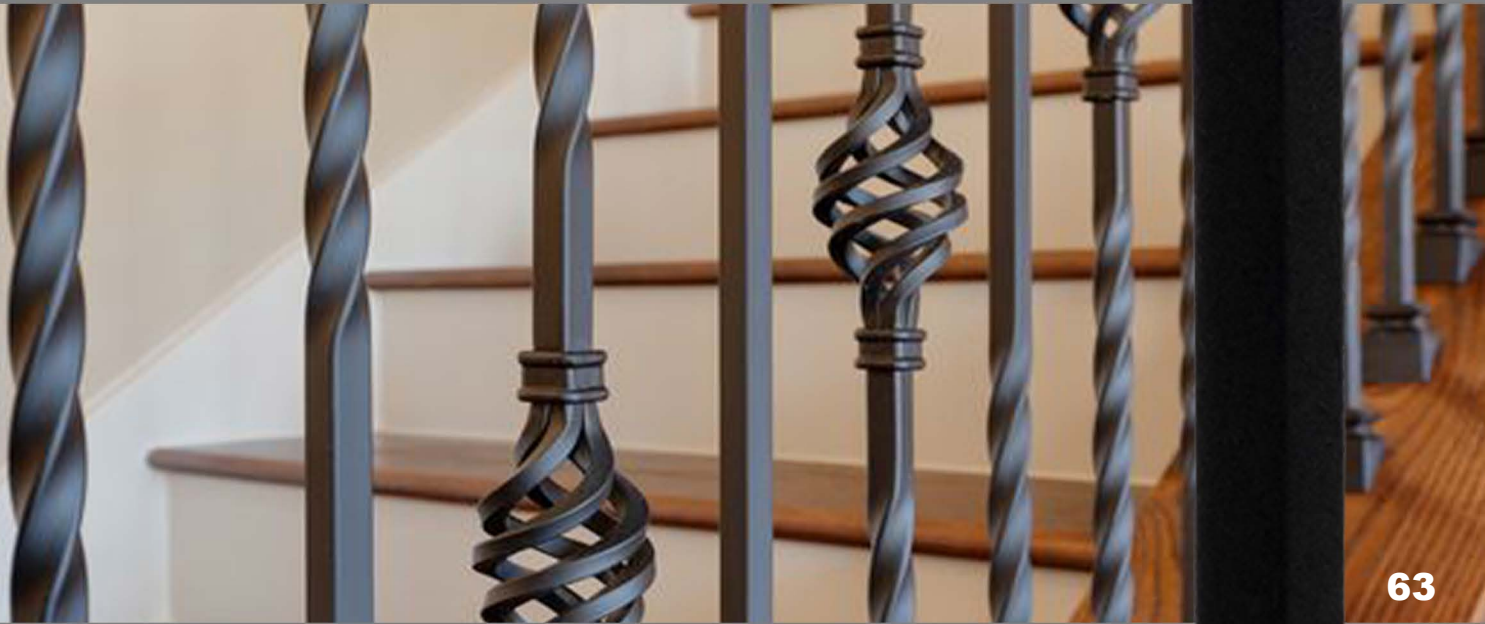

Horizontal Series



Satin Black



Ash Grey



Stainless Steel

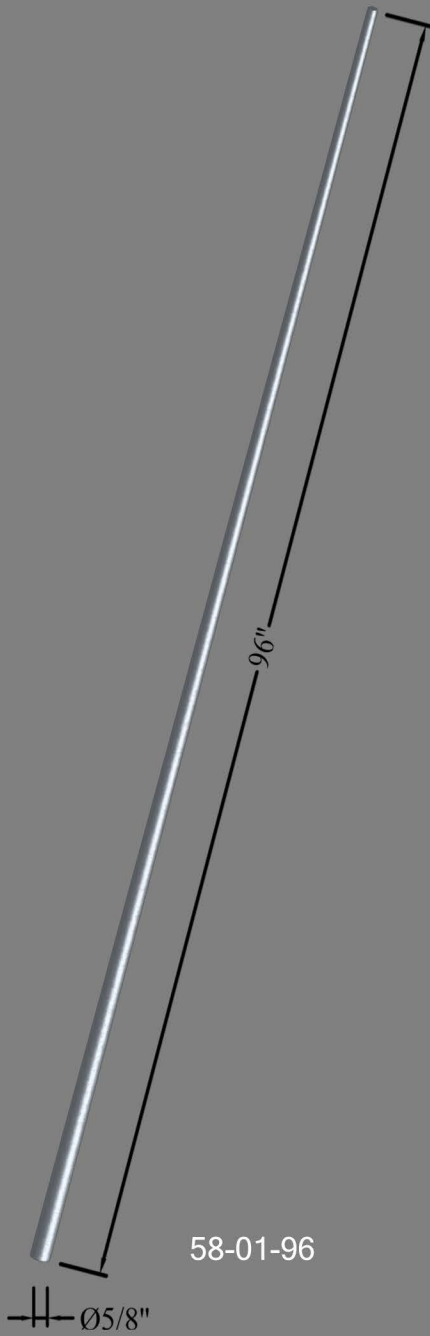





Iron Newels

Iron Newels

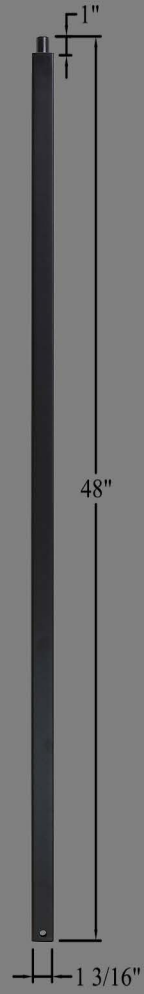

T-NWLPLA48



T-NWLTW48



T-NWLRIB48

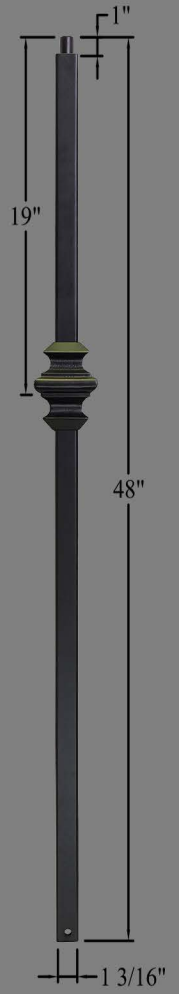

T-NWLKNUCK48



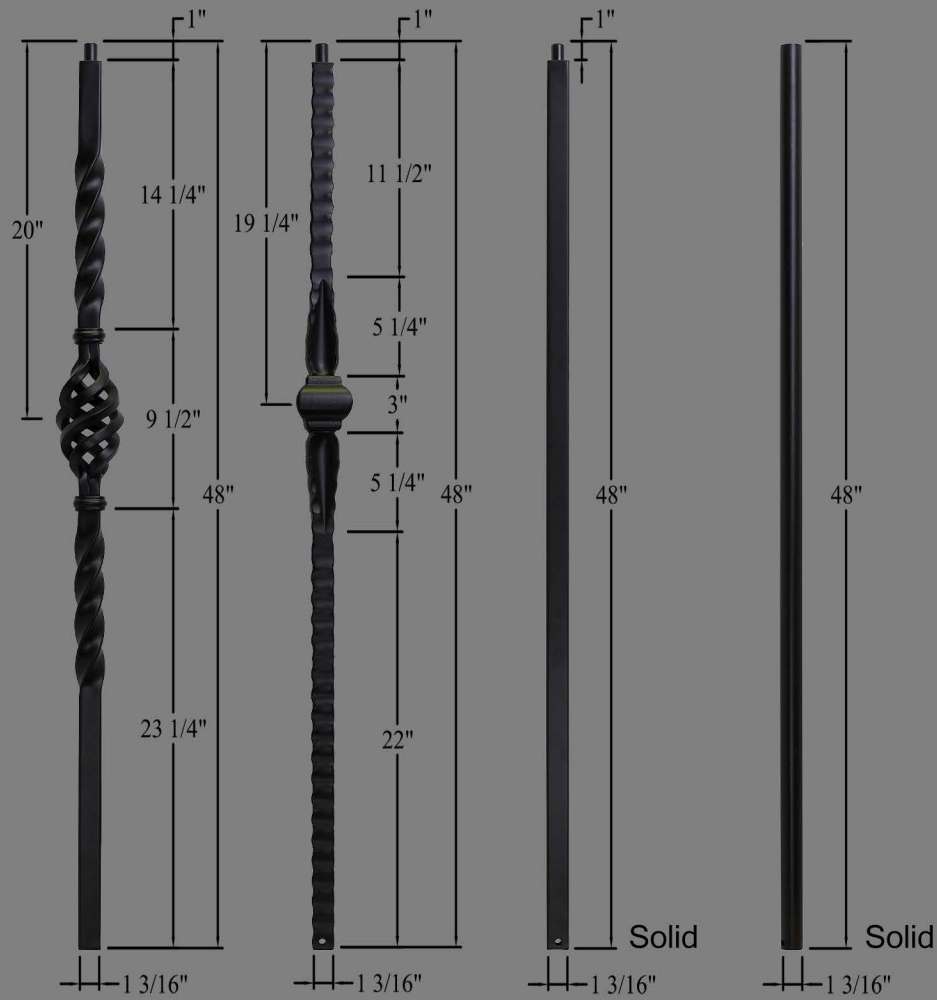

T-NWLBASK48

T-NWL14048

A-NWLPLA48

A-NWLRD48



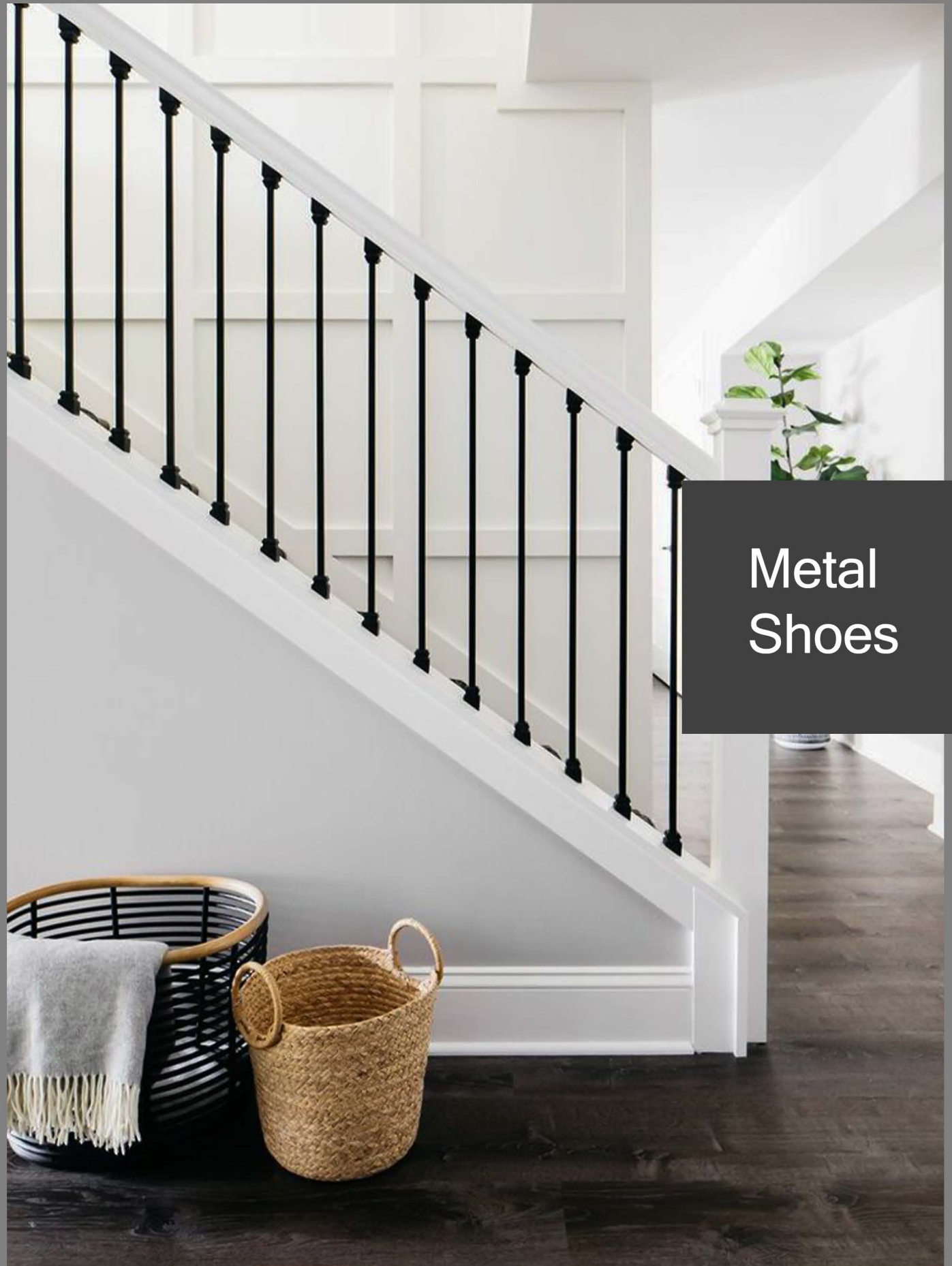

Metal Shoes

Metal Shoes



Satin Black



Ash Grey



Oil Rubbed Bronze



Oil Rubbed Copper

1/2" Shoes

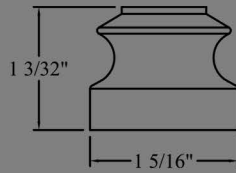

ALM-06

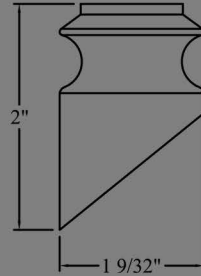

ALPSH-02

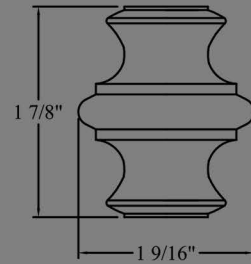

ALAK-01

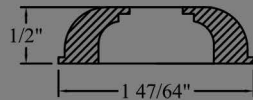

3109

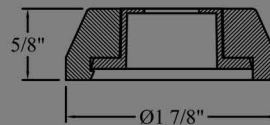

3.23

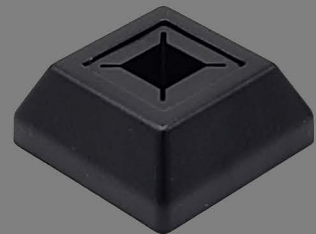
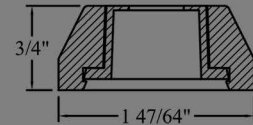

3.24

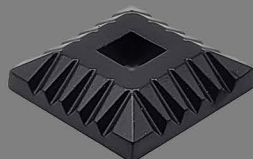
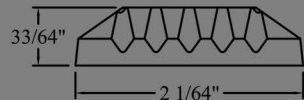

3.4

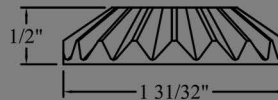

3.5

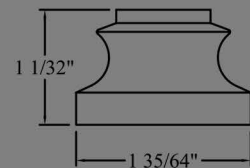

2340

9/16" Shoes

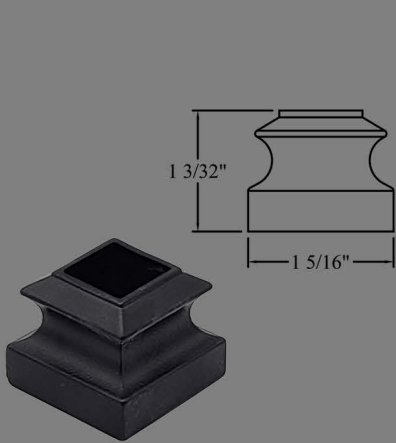

ALH-06

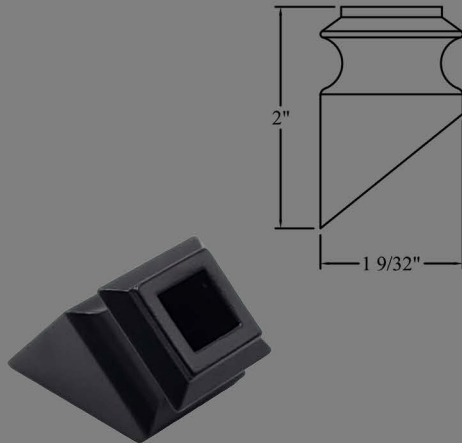

ALH05-P

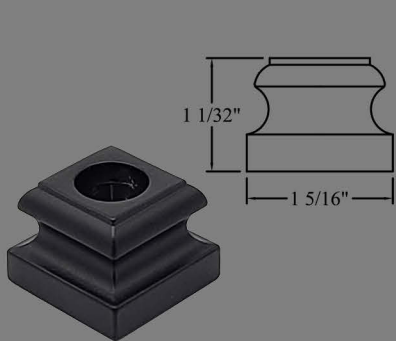

3.13

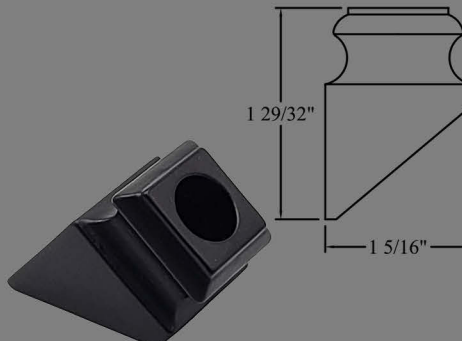

3.16

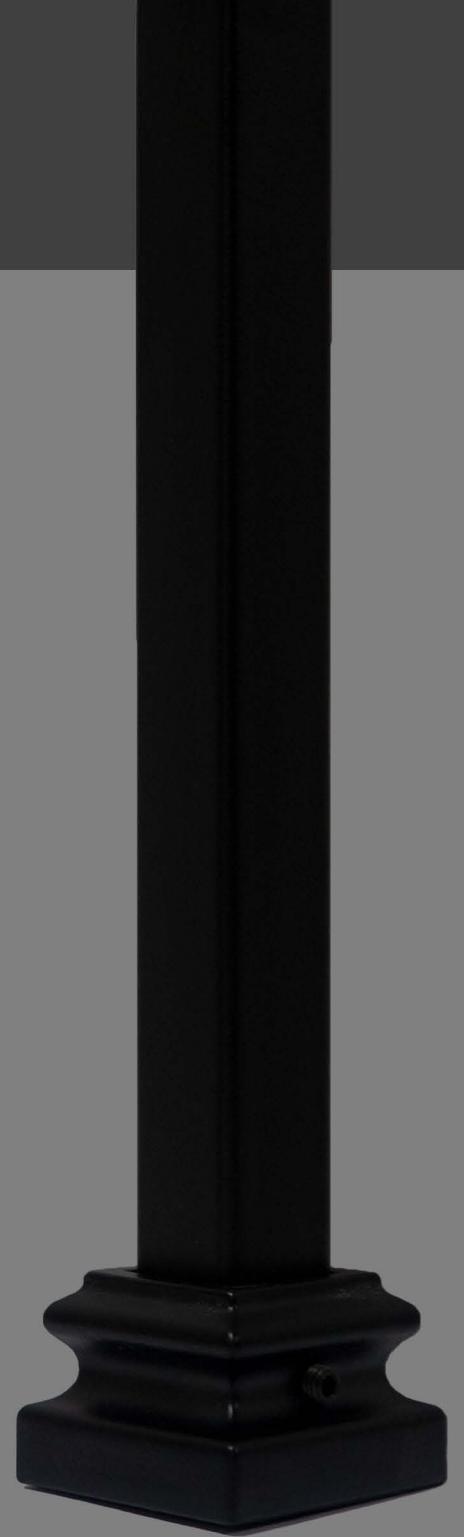

3/4" Mega Shoes

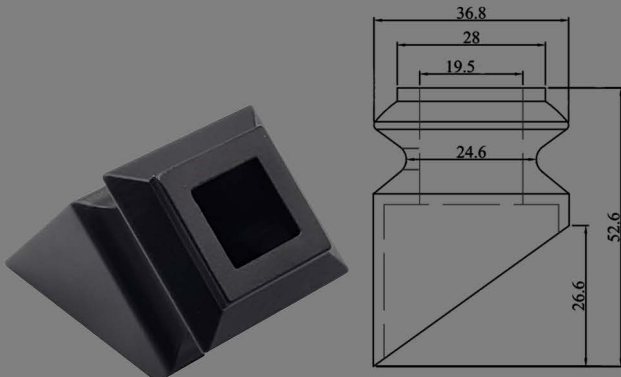

S-02

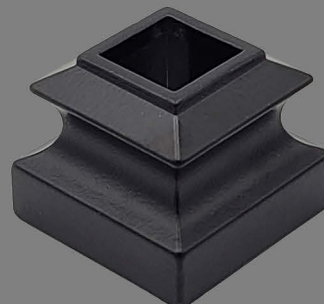

S-06

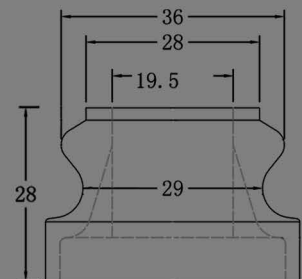

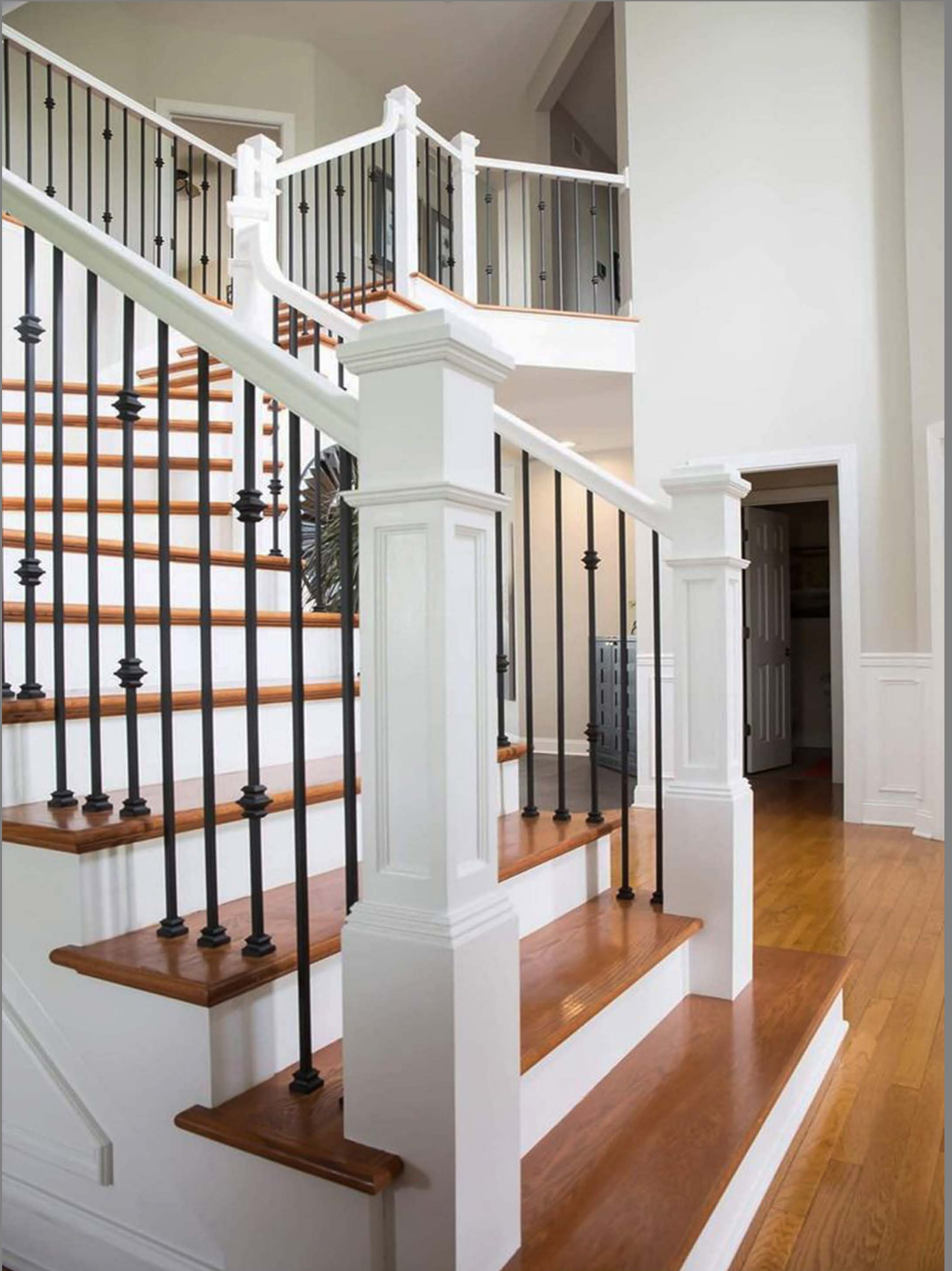

Stair Parts Accessories





Accessories

Wood

Caps

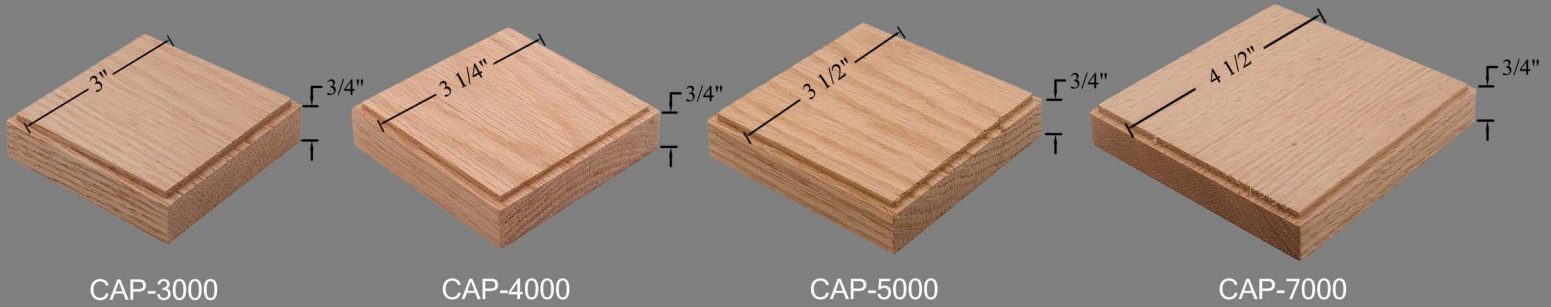

Tread Brackets

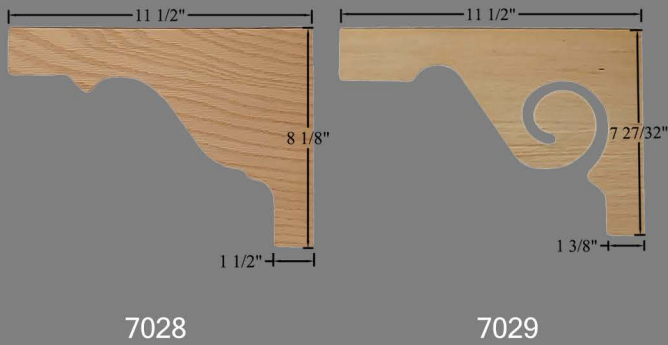

Tread Caps

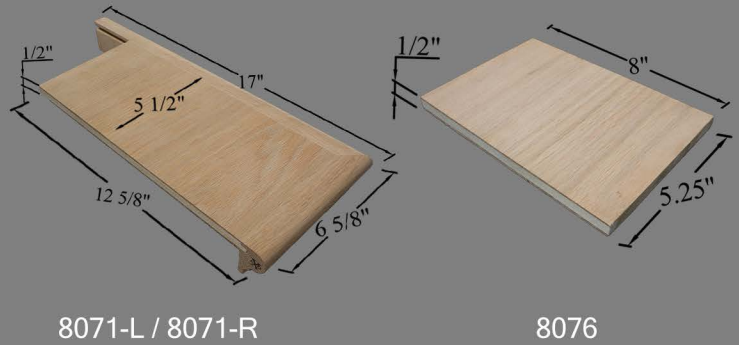

Rosettes



Plugs

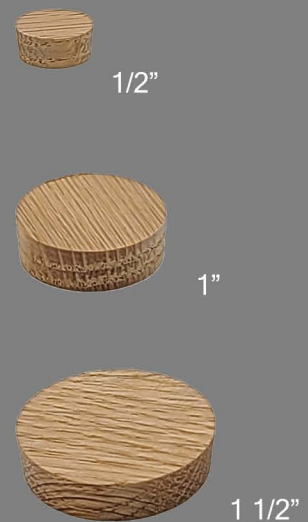

Metal / Adhesive



Brackets



3002HD

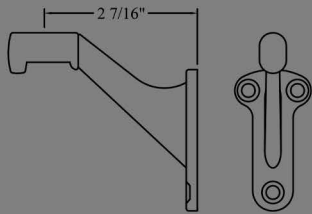

3003

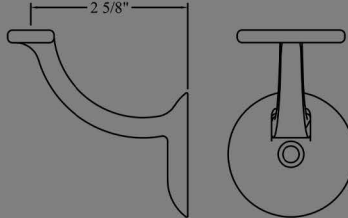

3004

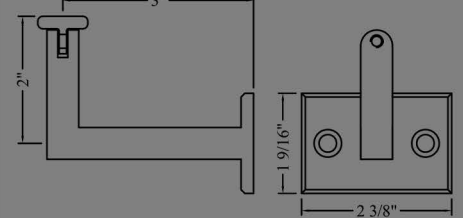

Fastener



3001



3076



3078



3008-10

Adhesive



PC-7
Epoxy Adhesive
Paste. Two-Part
Heavy Duty 1lb



Cartridge Titebond
Construction Adhe-
sive.
10.5 Ounce



8 oz



16 oz



1 Gallon

Titebond Wood Glue



Vinyl Floorings







LVP Flooring: 48" x 7"
Thickness: 3.5mm + 1mm EVA Pad
Wear Layer: 12 mil



Bryce



Hickory Bianco





Hickory Caramel



Hickory Ivory



Hickory Natural





Hickory Saddle

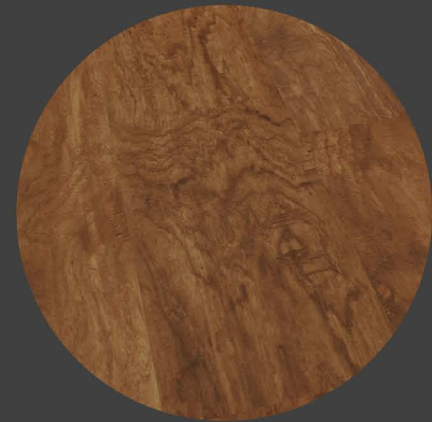

Hickory Toffee



Zion











1628 W. Crosby Rd. Suite 109
Carrollton, TX 75006



International Stair Products, Inc.



[internationalstair.products](https://www.instagram.com/internationalstair.products)



sales@internationalstair.com



(469) 453-6744



**INTERNATIONAL
STAIR PRODUCTS INC**



469-453-6744

www.intlstairproducts.com

1628 W. Crosby Road, Suite 109 Carrollton, TX 75006